

PROLUNGA CCpro *LONG CASING EXTENSION CCpro*

Permette la realizzazione, anche in sito, della versione a cassa lunga con girante e motore completamente protetti dalla cassa del ventilatore. Costruita in lamiera d'acciaio, con flange di fissaggio realizzate a norma UNI ISO 6580 – EUROVENT. Verniciata a polveri epossipoliestiriche. Completa di portellina d'ispezione e fori per passaggio cavi. Dimensioni CCpro 140 e 160 a richiesta.

Turns the standard short case execution into a long case version, also at site, with impeller and motor completely protected inside the casing. Manufactured in steel sheet, with fixing flanges according to UNI ISO6580 – EUROVENT standard. Protected against atmospheric agents by epoxy-paint. Complete of inspection porthole and holes for cable entry. Dimensions of CCpro 140 and 160 upon request.

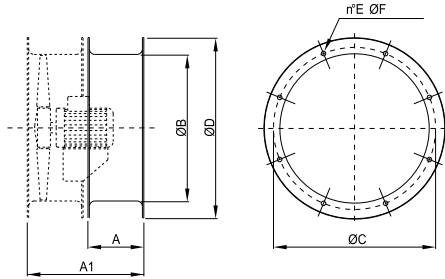

Cod.	TIPO TYPE	A	A1	ØB	ØC	ØD	E	ØF	kg
1CC9313	CCpro 31	180	380	315	355	395	8	10	4
1CC9351	CCpro 35	180	380	350	395	446	8	10	5
1CC9402	CCpro 40	200	430	400	450	496	8	12	5,5
1CC9451	CCpro 45	200	430	450	500	546	8	12	7
1CC9502	CCpro 50	200	450	500	560	598	12	12	7,5
1CC9561	CCpro 56	200	450	560	620	658	12	12	8,2
1CC9632	CCpro 63	240	490	630	690	730	12	12	10,5
1CC9712	CCpro 71	280	530	710	770	810	16	12	13
1CC9802	CCpro 80	240	590	800	860	910	16	12	20
1CC9901	CCpro 90	340	690	900	970	1030	16	16	30
1CC9912	CCpro 100	410	760	1000	1070	1130	16	16	39
1CC9921	CCpro 112	410	760	1120	1190	1250	20	16	58
1CC9927	CCpro 125	410	760	1250	1320	1380	20	16	65

Dimensioni in mm / Dimensions in mm

BOCCAGLIO CCbo *INLET/OUTLET CONE CCbo*

Permette un maggiore rendimento del ventilatore nel caso di bocche non canalizzate. Costruito in lamiera d'acciaio, con una flangia, realizzata a norma UNI ISO 6580 – EUROVENT, per il fissaggio al tamburo del CC e una bocca di aspirazione/diffusione ad ampio raggio con fori di fissaggio per rete CCr (di una taglia superiore, Es. CCbo 71 + CCr 80). Verniciato a polveri epossipoliestiriche.

It allows a higher fan efficiency in case of installation with inlet or outlet not ducted. Manufactured in steel sheet, with one flange according to UNI ISO6580 – EUROVENT to be fitted to the CC fan, and an aerodynamically shaped bell mouth, with fixing holes for a protection guard (of one size bigger, example CCbo 71 + CCr 80). Protected against atmospheric agents by epoxy paint.

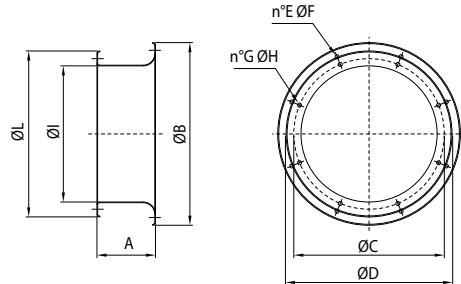

Cod.	TIPO TYPE	A	B	C	D	E	F	G	H	I	L	kg
5B09631	CCbo 31	175	442	355	395	8	10	8	10	307	395	4,4
5B09635	CCbo 35	175	496	395	450	8	12	8	10	357	446	5
5B09640	CCbo 40	175	546	450	500	8	12	8	12	407	496	5,6
5B09645	CCbo 45	175	598	500	560	12	12	8	12	457	546	6,3
5B09650	CCbo 50	190	658	560	620	12	12	12	12	507	598	8,5
5B09656	CCbo 56	190	730	620	690	12	12	12	12	567	658	8,5
5B09663	CCbo 63	190	810	690	770	16	12	12	12	637	730	9,8
5B09671	CCbo 71	230	910	770	860	16	12	16	12	708	810	12,4
5B09680	CCbo 80	250	1025	860	970	16	16	16	12	808	910	15,2
5B09690	CCbo 90	300	1125	970	1070	16	16	16	16	910	1030	29,4
5B09700	CCbo 100	300	1245	1070	1190	20	16	16	16	1010	1130	33,3
5B09712	CCbo 112	300	1380	1190	1320	20	16	20	16	1130	1250	37,3
5B09725	CCbo 125	300	1525	1320	1470	20	16	20	16	1260	1380	42,5
a rich.	CCbo 140	300	1735	1470	1680	24	18	20	16	1415	1540	49,8
a rich.	CCbo 160	300	1935	1680	1880	24	18	24	18	1615	1750	57,2

Dimensioni in mm / Dimensions in mm

GIUNTO ANTIVIBRANTE CCga *FLEXIBLE CONNECTORS CCga*

Impedisce la propagazione delle vibrazioni sulla canalizzazione. Costruito con due flange in lamiera d'acciaio, realizzate a norma UNI ISO 6580 – EUROVENT per il fissaggio al ventilatore e al canale, ed un nastro di collegamento flessibile e robusto. Temperature d'utilizzo -30°C +80°C. Parti in lamiera verniciate a polveri epossipoliestiriche. Per temperature d'utilizzo diverse sono previste costruzioni speciali. Dimensioni di CCga 140 e 160 a richiesta.

It prevents the propagation of vibrations along the ducted system. Manufactured with two flanges in steel sheet, according to UNI ISO6580 – EUROVENT standard for fixing to the fan and to the duct, and a strong flexible fabric joint. Working temperatures from -30°C to +80°C. Components in steel sheet protected against atmospheric agents by epoxy paint. Special executions are available for different working temperatures. Dimensions of CCga 140 and 160 upon request.

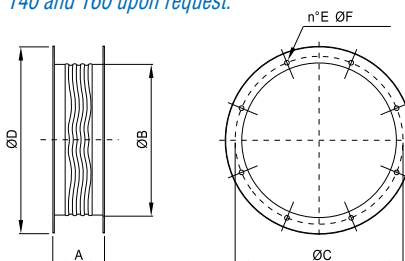

Cod.	TIPO TYPE	A	ØB	ØC	ØD	E	ØF	kg
1SU5310	CCga 31	200	315	355	395	8	10	5
1SU5350	CCga 35	200	350	395	446	8	10	6
1SU5400	CCga 40	200	400	450	496	8	12	7
1SU5450	CCga 45	200	450	500	546	8	12	8
1SU5500	CCga 50	200	500	560	598	12	12	9
1SU5560	CCga 56	200	560	620	658	12	12	10
1SU5630	CCga 63	200	630	690	730	12	12	11
1SU5710	CCga 71	200	710	770	810	16	12	13
1SU5800	CCga 80	200	800	860	910	16	12	21
1SU5900	CCga 90	200	900	970	1030	16	16	23
1SU6000	CCga 100	200	1000	1070	1130	16	16	26
1SU6120	CCga 112	200	1120	1190	1250	20	16	29
1SU6125	CCga 125	200	1250	1320	1380	20	16	32

Dimensioni in mm / Dimensions in mm

sez. 1.3

RETI PROTEZIONE CCr/CCrc PROTECTION GUARDS CCr/CCrc

Salvaguardano dal contatto accidentale con le parti in movimento del ventilatore. Realizzate in filo d'acciaio, a norma UNI 12499 e protette contro gli agenti atmosferici. CCr: versione piana (per cassa lunga e cassa corta lato girante). CCrc: versione conica (cassa corta lato motore). Non disponibile su CCZ.

They prevent from casual contact with moving parts of the fan. Manufactured in steel rod according to UNI 12499 standard and protected against atmospheric agents. CCr: flat version (for long case and short case on impeller side). CCrc: conic version (short case version on motor side). Not available on CCZ

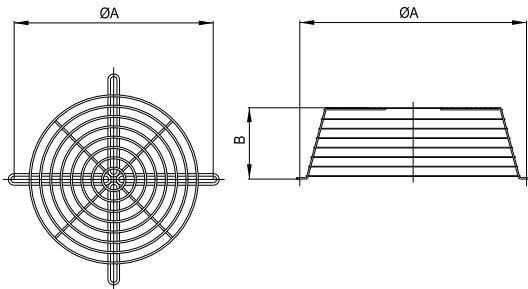

Cod.	TIPO TYPE	ØA	kg	Cod.	TIPO TYPE	ØA	B	kg
5RE9031	CCr 31	355	0,4	5RE1581	CCrc 31	355	115	1
5RE9035	CCr 35	395	0,6	5RE1582	CCrc 35	395	115	1,1
5RE9040	CCr 40	450	0,7	5RE1583	CCrc 40	450	115	1,3
5RE9045	CCr 45	500	1	5RE1584	CCrc 45	500	115	1,5
5RE9050	CCr 50	560	1,4	5RE1585	CCrc 50	560	115	1,8
5RE9056	CCr 56	620	2	5RE1586	CCrc 56	620	115	2,2
5RE9063	CCr 63	690	2,2	5RE1587	CCrc 63	690	115	3
5RE9071	CCr 71	770	2,7	5RE1588	CCrc 71	770	150	4,5
5RE9080	CCr 80	860	4	5RE1589	CCrc 80	860	150	5,8
5RE9090	CCr 90	970	5	5RE1590	CCrc 90	970	305	7
5RE9100	CCr 100	1070	5	5RE1591	CCrc 100	1070	305	8,5
5RE9102	CCr 112	1190	6	5RE1592	CCrc 112	1190	305	10
5RE9105	CCr 125	1320	9	5RE1593	CCrc 125	1320	305	11
5RE9110	CCr 140	1490	12					
5RE9113	CCr 160	1690	14					

STAFFE DI SOSTEGNO CCst SUPPORT FEET CCst

Consentono l'ancoraggio del ventilatore a pavimento o soffitto. Realizzate in lamiera d'acciaio e verniciate a polveri epossipoliestiriche.

Suitable to fasten the fan on the floor or to the ceiling. Manufactured in steel sheet and protected against atmospheric agents by epoxy paint.

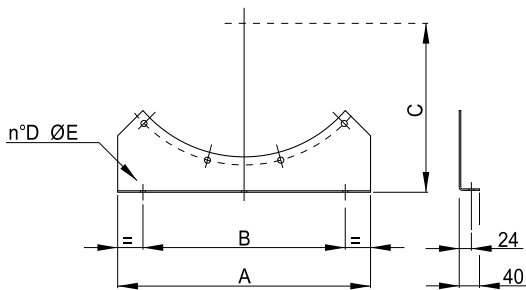

Cod.	TIPO TYPE	A	B	C	D	ØE	kg
1ST0310	CCst 31	320	200	280	2	10	1,1
1ST0350	CCst 35	350	250	300	2	10	1,25
1ST0400	CCst 40	400	300	320	2	10	1,3
1ST0450	CCst 45	450	350	350	2	10	1,5
1ST0500	CCst 50	500	400	380	3	10	2,1
1ST0560	CCst 56	560	460	410	3	10	2,5
1ST0630	CCst 63	630	480	450	3	10	2,8
1ST0710	CCst 71	700	550	490	3	10	3,1
1ST0800	CCst 80	800	660	540	3	14	3,7
1ST0900	CCst 90	900	760	600	3	14	4,5
1ST1000	CCst 100	1000	860	640	3	14	4,7
1ST1120	CCst 112	1120	820	710	3	14	6,8
1ST1250	CCst 125	1250	950	770	3	14	7,7
1ST1400	CCst 140	1400	1100	850	3	14	11,0
1ST1600	CCst 160	1600	1300	960	3	16	21,5

Dimensioni in mm / Dimensions in mm

CONTROFLANGIA PIANA CCf COUNTER FLANGE FLAT CCf

Piastra a forma di anello provvista di fori a norma UNI ISO 6580 – EUROVENT. Viene utilizzata per facilitare il collegamento tra il canale ed il ventilatore.

Ring plate with holes according to UNI ISO6580 – EUROVENT standard, compatible with fan flange. It is used for easier connection between the CC fan and the duct.

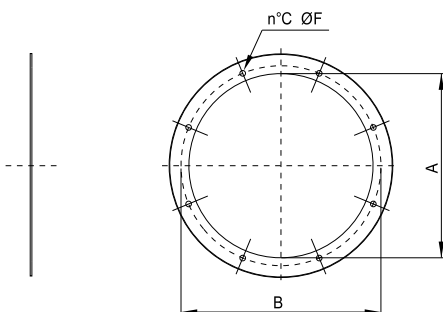

Cod.	TIPO TYPE	ØA	ØB	C	ØD	kg
5B01031	CCf 31	315	355	8	10	1,2
5B01035	CCf 35	350	395	8	10	1,5
5B01040	CCf 40	400	450	8	12	1,7
5B01045	CCf 45	450	500	8	12	1,9
5B01050	CCf 50	500	560	12	12	2,1
5B01056	CCf 56	560	620	12	12	2,4
5B01063	CCf 63	630	690	12	12	2,7
5B01071	CCf 71	710	770	16	12	3,3
5B01081	CCf 80	800	860	16	12	3,7
5B01092	CCf 90	900	970	16	16	4,7
5B01110	CCf 100	1000	1070	16	16	5,2
5B01212	CCf 112	1120	1190	20	16	7,2
5B01210	CCf 125	1250	1320	20	16	8

Dimensioni in mm / Dimensions in mm

CONTROFLANGIA CON COLLARE CCfc COUNTER FLANGE WITH COLLAR CCfc

Controflangia a forma di anello con collare, provvista di fori a norma UNI ISO 6580 – EUROVENT. Viene utilizzata per facilitare il collegamento tra il canale ed il ventilatore.

Counter flange with addition of 80 mm of round duct. It is used for easier connection between the CC fan and the duct.

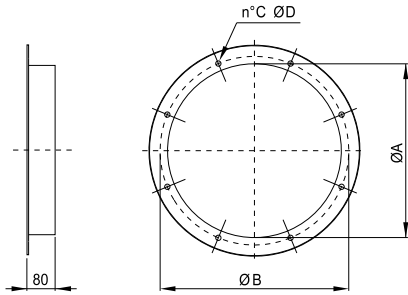

Cod.	TIPO TYPE	ØA	ØB	C	ØD	kg
5B01531	CCfc 31	315	355	8	10	1,3
5B01535	CCfc 35	350	395	8	10	1,5
5B01540	CCfc 40	400	450	8	12	1,7
5B01545	CCfc 45	450	500	8	12	2
5B01550	CCfc 50	500	560	12	12	2,2
5B01556	CCfc 56	560	620	12	12	2,5
5B01563	CCfc 63	630	690	12	12	2,9
5B01571	CCfc 71	710	770	16	12	3,3
5B01580	CCfc 80	800	860	16	12	3,8
5B01590	CCfc 90	900	970	16	16	4,2
5B01600	CCfc 100	1000	1070	16	16	5
5B01620	CCfc 112	1120	1190	20	16	5,8
5B01625	CCfc 125	1250	1320	20	16	6,5

Dimensioni in mm / Dimensions in mm

SILENZIATORI CILINDRICI CCsa/CCsb CYLINDRICAL SILENCERS CCsa/CCsb

I silenziatori cilindrici CCs sono disponibili in due versioni, senza ogiva (CCsa) e con ogiva (CCsb). La presenza dell'ogiva permette una maggiore attenuazione della rumorosità ma genera una perdita di carico aggiuntiva nell'impianto. Entrambe le versioni possono essere fissate alla flangia del CC corrispondente sia in aspirazione sia in mandata. La serie CCsa, non genera perdite di carico aggiuntive. La serie CCsb, comporta una perdita di carico nella misura evidenziata nel diagramma di pagina 123.

E' possibile fornire i silenziatori in versione di lunghezza pari a 1 - 1,5 - 2 volte il diametro (b). Questi silenziatori sono costruiti completamente in lamiera zincata, la parte interna e l'ogiva in lamiera forata al fine di permettere, efficacemente, l'azione del materassino fonoassorbente in lana minerale. La temperatura d'esercizio è compresa fra -40 e +150°C in servizio S1.

The cylindrical silencers CCs are available in two versions, without pod (CCsa) and with pod (CCsb). The presence of the pod allows a higher noise attenuation, but creates an additional pressure drop in the system. Both the versions can be fixed to the corresponding flange of the CC in inlet and outlet. The CCsa series doesn't create additional losses. The CCsb series gives an additional loss, as shown in the diagram at page 123.

Silencers can be provided with length equal to 1 - 1,5 - 2 times the diameter (b). These silencers are manufactured completely in galvanized steel. The internal part and the pod are made in perforated sheet, to effectively allow the sound absorption of the acoustic lining in mineral wool. The working temperature is included from -40°C and +150°C in S1 service.

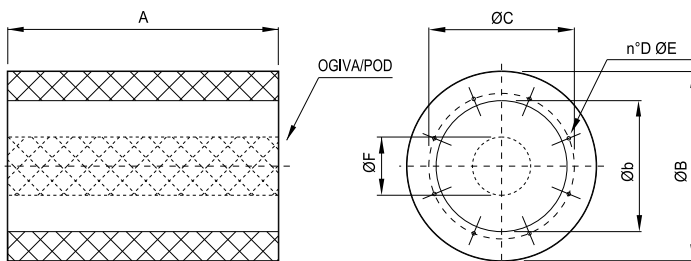

TIPO / TYPE	ØB	Øb	ØC	D	ØE	ØF
31	455	315	355	8	M8	140
35	495	355	395	8	M8	200
40	540	400	450	8	M10	200
45	610	450	500	8	M10	245
50	660	500	560	12	M10	245
56	720	560	620	12	M10	295
63	790	630	690	12	M10	295
71	870	710	770	16	M10	380
80	1000	800	860	16	M10	380
90	1100	900	970	16	M12	380
100	1200	1000	1070	16	M12	650
112	1320	1120	1190	20	M12	650
125	1450	1250	1320	20	M12	650

Dimensioni in mm / Dimensions in mm

TIPO / TYPE	CCsa	A 1Ø	kg	A 1,5Ø	kg	A 2Ø	kg
31	315	8	470	11	630	14	
35	350	10	525	14	700	17	
40	400	12	600	17	800	21	
45	450	15	675	20	900	24	
50	500	18	750	25	1000	32	
56	560	21	840	28	1120	35	
63	630	24	945	33	1260	43	
71	710	35	1065	49	1420	63	
80	800	43	1200	61	1600	79	
90	900	70	1350	94	1800	112	
100	1000	113	1500	137	2000	161	
112	1120	130	1680	154	2240	178	
125	1250	152	1875	185	2500	213	

Dimensioni in mm / Dimensions in mm

TIPO / TYPE	CCsb	A 1Ø	kg	A 1,5Ø	kg	A 2Ø	kg
31	315	10	470	14	630	16	
35	350	12	525	16	700	18	
40	400	14	600	21	800	26	
45	450	17	675	24	900	29	
50	500	23	750	32	1000	39	
56	560	28	840	37	1120	44	
63	630	32	945	44	1260	55	
71	710	44	1065	62	1420	78	
80	800	56	1200	79	1600	101	
90	900	130	1350	153	1800	175	
100	1000	143	1500	180	2000	216	
112	1120	165	1680	202	2240	238	
125	1250	193	1875	240	2500	282	

Dimensioni in mm / Dimensions in mm

sez. 1.3

CCsa: silenzianti senza ogiva / without pod

A= 1 x Øb

Attenuazione in dB per banda di ottava (Hz) Octave spectrum (Hz) of noise attenuation in dB								
TIPO / TYPE								
CCsa	63	125	250	500	1K	2K	4K	8K
31	1	1	3	8	14	9	8	7
35	0	0	3	9	14	10	8	6
40	0	0	4	10	13	8	8	5
45	1	1	4	12	12	9	6	6
50	0	0	4	13	11	9	6	5
56	0	0	4	14	11	8	5	4
63	1	1	5	14	10	9	5	5
71	1	1	5	12	9	7	5	5
80	2	3	7	9	8	6	5	4
90	2	3	7	13	8	6	5	4
100	2	3	8	12	8	4	4	4
112	2	3	8	13	7	5	4	3
125	2	3	9	13	7	4	4	3

CCsb: silenzianti con ogiva / with pod

A= 1 x Øb

Attenuazione in dB per banda di ottava (Hz) Octave spectrum (Hz) of noise attenuation in dB								
TIPO / TYPE								
CCsb	63	125	250	500	1K	2K	4K	8K
31	0	1	4	9	16	17	13	10
35	0	0	4	11	22	21	15	12
40	0	1	4	11	20	18	14	11
45	0	1	6	14	21	19	13	9
50	1	2	5	13	20	16	11	8
56	1	1	6	15	21	17	11	8
63	1	1	6	15	19	16	10	8
71	1	2	7	15	20	18	12	10
80	2	3	9	12	17	15	9	8
90	2	4	8	15	16	11	8	7
100	4	8	14	20	24	21	14	10
112	4	6	13	20	21	14	8	7
125	4	7	12	18	19	10	6	6

A= 1,5 x Øb

Attenuazione in dB per banda di ottava (Hz) Octave spectrum (Hz) of noise attenuation in dB								
TIPO / TYPE								
CCsa	63	125	250	500	1K	2K	4K	8K
31	1	2	5	12	19	13	11	8
35	0	0	5	12	21	13	11	9
40	1	1	5	14	19	12	10	8
45	1	1	6	17	17	13	9	8
50	1	1	6	18	17	12	9	7
56	1	2	7	20	15	11	8	5
63	1	2	7	20	14	12	8	6
71	2	2	7	18	11	9	6	7
80	2	5	10	13	12	9	7	7
90	2	5	11	16	11	7	7	5
100	2	5	12	17	10	6	6	5
112	3	5	12	18	8	6	5	4
125	3	6	12	17	8	5	5	4

A= 1,5 x Øb

Attenuazione in dB per banda di ottava (Hz) Octave spectrum (Hz) of noise attenuation in dB								
TIPO / TYPE								
CCsb	63	125	250	500	1K	2K	4K	8K
31	2	4	5	13	23	26	18	12
35	1	1	7	15	33	32	22	17
40	1	2	6	15	31	27	19	14
45	1	2	7	19	31	28	18	12
50	2	3	7	19	29	24	14	10
56	2	3	9	22	32	27	15	11
63	2	2	9	22	29	23	14	10
71	2	3	11	22	31	25	13	11
80	3	6	13	18	26	22	12	11
90	3	5	12	20	24	16	10	9
100	6	10	22	30	37	29	16	12
112	6	10	19	29	33	20	11	10
125	6	10	18	26	29	14	9	7

A= 2 x Øb

Attenuazione in dB per banda di ottava (Hz) Octave spectrum (Hz) of noise attenuation in dB								
TIPO / TYPE								
CCsa	63	125	250	500	1K	2K	4K	8K
31	4	6	6	16	26	17	13	9
35	0	2	6	15	25	16	12	10
40	0	2	7	18	24	15	12	9
45	0	1	7	21	21	15	10	8
50	1	2	8	23	21	14	11	8
56	1	1	9	24	19	14	10	7
63	1	2	9	25	17	14	10	7
71	2	4	9	24	14	11	8	8
80	4	6	13	22	14	10	9	7
90	4	6	14	23	13	9	7	6
100	4	6	16	23	12	7	7	6
112	4	6	15	23	10	7	6	6
125	5	8	17	22	10	6	6	5

A= 2 x Øb

Attenuazione in dB per banda di ottava (Hz) Octave spectrum (Hz) of noise attenuation in dB								
TIPO / TYPE								
CCsb	63	125	250	500	1K	2K	4K	8K
31	3	6	7	17	32	33	22	17
35	1	2	8	19	40	39	27	20
40	1	2	9	20	37	35	23	16
45	2	3	10	23	39	36	21	15
50	2	3	10	24	38	32	18	12
56	1	2	12	27	41	35	18	12
63	2	3	11	27	37	29	15	12
71	3	5	14	29	41	32	18	15
80	3	6	16	29	35	26	15	12
90	4	7	17	30	34	20	12	11
100	7	13	28	39	47	38	19	13
112	8	14	26	36	42	24	13	11
125	7	13	25	35	37	17	11	9

sez. 1.3

N.B.: Versioni senza ogiva (CCsa) hanno perdita di carico irrilevante.
 Without pod (CCsa) loss charge irrelevant

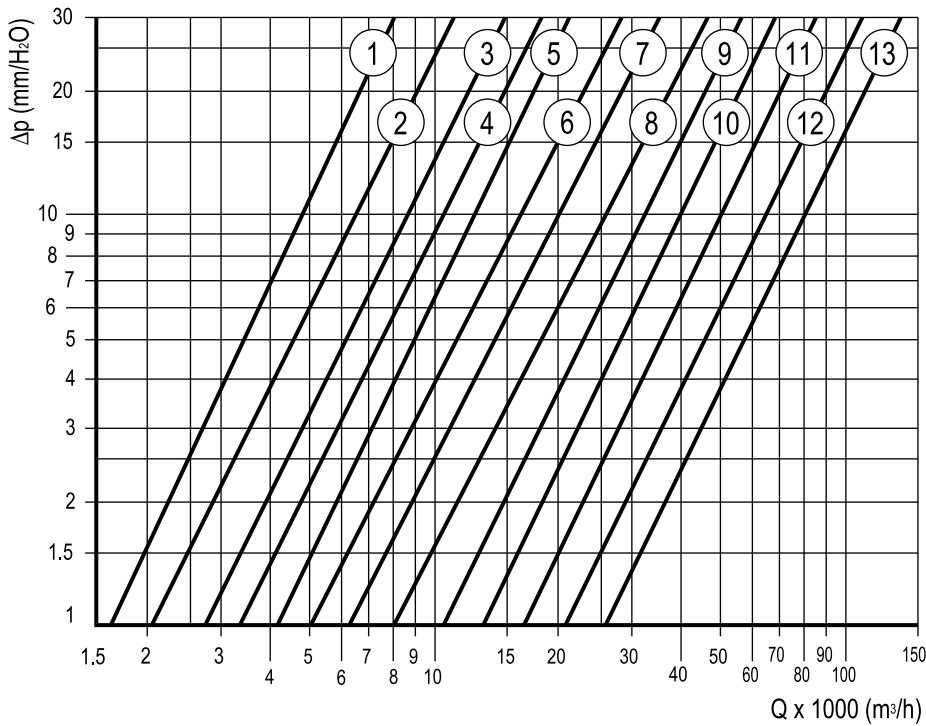

TIPO TYPE	n°
CCsb 31	1
CCsb 35	2
CCsb 40	3
CCsb 45	4
CCsb 50	5
CCsb 56	6
CCsb 63	7
CCsb 71	8
CCsb 80	9
CCsb 90	10
CCsb 100	11
CCsb 112	12
CCsb 125	13

sez. 1.3

