

> AC-A & AC-B

Ventilatori assiali ad anello

Ring axial fans



AC-A Boccaglio raggato in aspirazione.
Shaped cone on inlet side.



AC-B Boccaglio raggato in aspirazione e mandata.
Shaped cone on inlet and outlet sides.



Conformi alla Direttiva ErP e al Regolamento UE 327/2011 (FAN)

Categoria di misura: C
Categoria di efficienza: Statica
In conformità a EN ISO 5801 / AMCA 210.

Compliant with Erp Directive and EU Regulation 327/2011 (FAN)

Measurement category: C
Efficiency category: Static
According to EN ISO 5801 / AMCA 210.

DESCRIZIONE GENERALE

I ventilatori della serie AC sono adatti per la ventilazione nelle più svariate applicazioni civili, industriali e commerciali in cui siano richieste elevate portate d'aria con aspirazione non canalizzata. Sono utilizzabili come componenti (OEM) in una vasta gamma di applicazioni. Con l'aggiunta della piastra di fissaggio, il ventilatore (dalla taglia 710 alla 1250) si trasforma in un ventilatore assiale da parete (come la gamma QC). La serie è costituita da 2 versioni: AC/A ed AC/B, con diametro girante da 300 a 1250 mm e con differenti polarità. L'AC/A ha il boccaglio raggato solo in aspirazione mentre l'AC/B anche sulla mandata. L'impiego della serie AC è previsto con aria pulita, nell'intervallo di temperatura da -15°C a +50°C.

Il boccaglio ottimizzato in aspirazione riduce il rumore e aumenta l'efficienza aeraulica.

CONSTRUZIONE

- Anello in lamiera d'acciaio verniciato a polveri epossipoliestiriche.
- Girante con pale a profilo alare in nylon-vetro e mozzo in fusione di lega d'alluminio. Angolo di calettamento variabile da fermo tramite tasselli di regolazione. Bilanciata secondo ISO 1940.
- Esecuzione 4 (accoppiamento diretto con girante a sbalzo). Flusso dell'aria da motore a girante.
- Rete di protezione lato motore in tondino d'acciaio trafilato saldata sull'anello. Realizzata a norme UNI 12499.
- Motore asincrono trifase o monofase a norme internazionali IEC 60034, IEC 60072, EMC 2014/30/UE, LVD 2014/35/UE e marcato CE IP55, classe F. Idoneo ad un servizio S1 (funzionamento continuo a carico costante).

ACCESSORI

- Rete di protezione lato girante, realizzata a norme UNI 12499 (CCr) solo per versione AC/B
- Piastra quadra per fissaggio a muro in lamiera verniciata a polveri epossipoliestiriche.

A RICHIESTA

- Girante con pale a profilo alare in lega d'alluminio.
- Flusso dell'aria da girante a motore (solo AC/B).

GENERAL DESCRIPTION

The fans of the AC series are suitable for the ventilation in residential, commercial and industrial buildings in which are requested relevant air deliveries without canalization. They are also suitable as OEM in a wide variety of applications. With the addition of a suitable wall mounting square frame adaptor, the AC fans (from size 710 to 1250) can be converted in a wall mounted fan (like QC range).

The series includes 2 versions: AC/A and AC/B, with impeller diameter from 300 a 1250 mm and different motor polarity. The AC-A model has a shaped cone in the inlet side, while for the AC/B the shaped cone is present also on the outlet. They are designed for clean air in the temperature range -15°C +50°C.

The optimized inlet cone reduces noise level and increases the efficiency.

CONSTRUCTION

- Ring frame in steel sheet. AC/A with shaped cone only on inlet side; AC/B with shaped cone on inlet and outlet side. Protected against the atmospheric agents by epoxy paint.
- Axial impeller with aerofoil profile blades in glass reinforce polyamide and die-cast aluminium hub, balanced according ISO 1940. Variable pitch angle in still position with setting means.
- Execution 4 (impeller directly coupled to motor shaft). Air flow from motor to impeller.
- Inlet protection guard in steel rod directly welded on the ring frame, according to UNI12499 norm.
- Asynchronous three-phase or single-phase motors according to international standards IEC 60034, IEC 60072, EEMC 2014/30/UE, LVD 2014/35/UE, CE marked, IP 55, class F. Service S1 (continuous working to constant load).

ACCESSORIES

- Impeller side protection guard, according to UNI 12499 norm (CCr) only for AC/B.
- Wall mounting square frame adaptor in epoxy painted steel sheet.

UPON REQUEST

- Impeller with airfoil blades in die-cast aluminium alloy.
- Airflow from impeller to motor (only AC/B).

sez.
1.2

Le prestazioni aeruliche sono rilevate in conformit  alla norma EN ISO 5801/AMCA 210 con densit  dell'aria standard avente peso specifico 1.2 Kg/m³.
Conformi alla Direttiva ErP 2009/125/CE e al regolamento UE327/2011.
Categoria di misura: C. Categoria di efficienza: Statica.
Alimentazione 230V/1Ph/50Hz o 400V/3Ph/50Hz.

Air performances measured according to EN ISO 5801 / AMCA 210 standard with air density with 1.2 kg/m³ specific weight.
Compliant with ErP 2009/125/EC Directive and EU Regulation 327/2011.
Measurement category: C. Efficiency category: Static.
Power supply 230V/1Ph/50Hz or 400V/3Ph/50Hz.

Lp: Livello di pressione sonora rilevato in condizioni di campo libero, propagazione emisferica, categoria di misura C a norma EN ISO 13349, nel punto di massimo rendimento, alla distanza di 3 metri dal lato aspirazione e si presenta solo per fini comparativi.
Lw: Livello di potenza sonora ottenuto secondo norma ISO 3746. Tolleranza +/- 3 dB(A).

Lp: Sound pressure level measured in free field conditions, propagation hemispherical, measurement category C in accordance with EN ISO 13349, at the point of maximum efficiency at a distance of 3 meters, inlet side (for comparative purposes only).
Lw: Sound power level obtained in accordance with EN ISO 3746. Tolerance +/- 3 dB(A).

AC 300

Cod.	Tipo Type	Modello Model	Ventola Impeller	U	P	P (kW)	In (A)	IP/CL	Mot. (Gr)
1AC0034 / 1AC2030	AC - A/B	312	3H-4-25	T	2	0,25	0,63	55/F	63
1AC0033 / 1AC2033	AC - A/B	314	DY-6-45	M	4	0,09	1,3	55/F	56
1AC0032 / 1AC2032	AC - A/B	314	DY-6-45	T	4	0,09	0,4	55/F	56

Livelli sonori - Sound levels / dB(A)

[Hz]	63	125	250	500	1000	2000	4000	8000	TOT
AC 312 Lw	57	68	75	83	84	83	82	77	90
AC 312 Lp	40	51	58	66	67	66	65	60	72
AC 314 Lw	41	51	56	62	65	65	66	60	71
AC 314 Lp	24	34	39	45	48	48	49	43	54

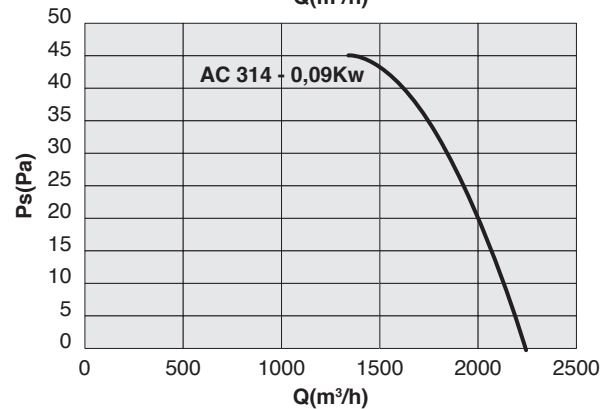
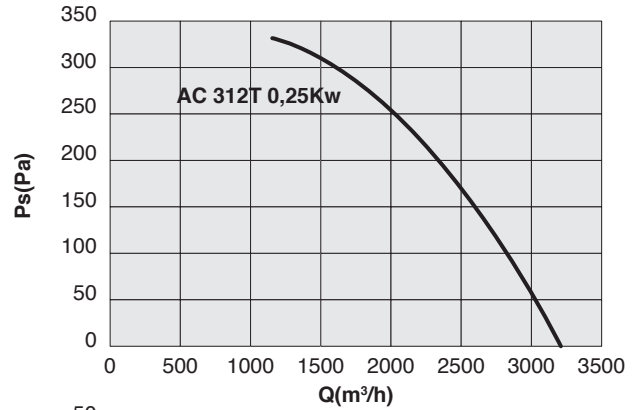

AC 350

Cod.	Tipo Type	Modello Model	Ventola Impeller	U	P	P (kW)	In (A)	IP/CL	Mot. (Gr)
1AC0035 / 1AC2035	AC - A/B	352	DY-6-30	T	2	0,55	1,27	55/F	71
1AC0038 / 1AC2038	AC - A/B	354	DY-6-45	M	4	0,12	1,3	55/F	63
1AC0037 / 1AC2037	AC - A/B	354	DY-6-45	T	4	0,12	0,4	55/F	63

Livelli sonori - Sound levels / dB(A)

[Hz]	63	125	250	500	1000	2000	4000	8000	TOT
AC 352 Lw	57	68	74	79	82	82	83	78	88
AC 352 Lp	40	51	57	62	65	65	66	61	71
AC 354 Lw	42	52	57	63	66	66	66	61	72
AC 354 Lp	25	35	40	46	49	49	49	44	54
AC 354 Lw	42	52	57	63	66	66	66	61	72
AC 354 Lp	25	35	40	46	49	49	49	44	54

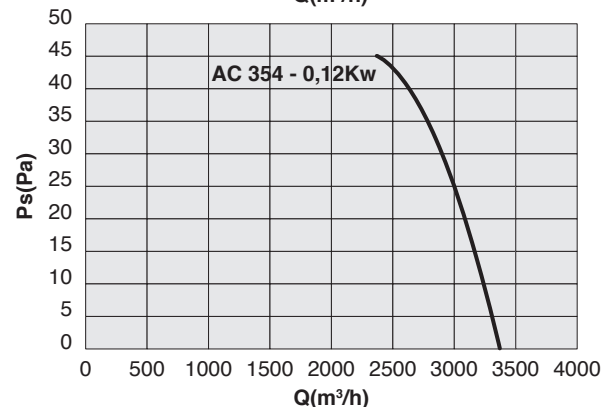
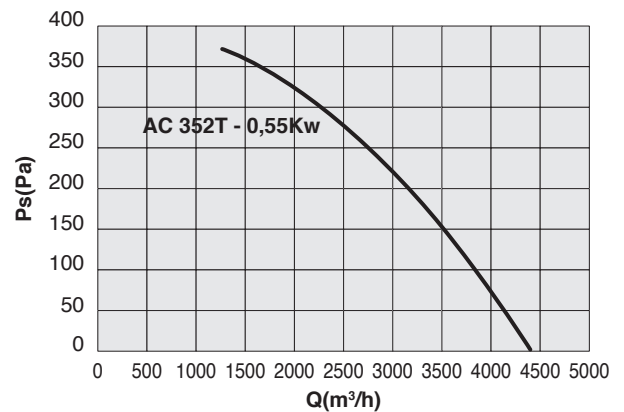

Le prestazioni aeruliche sono rilevate in conformit  alla norma EN ISO 5801/AMCA 210 con densit  dell'aria standard avente peso specifico 1.2 Kg/m³.
Conformi alla Direttiva ErP 2009/125/CE e al regolamento UE327/2011.
Categoria di misura: C. Categoria di efficienza: Statica.
Alimentazione 230V/1Ph/50Hz o 400V/3Ph/50Hz.

Air performances measured according to EN ISO 5801 / AMCA 210 standard with air density with 1.2 kg/m³ specific weight.
Compliant with ErP 2009/125/EC Directive and EU Regulation 327/2011.
Measurement category: C. Efficiency category: Static.
Power supply 230V/1Ph/50Hz or 400V/3Ph/50Hz.

Lp: Livello di pressione sonora rilevato in condizioni di campo libero, propagazione emisferica, categoria di misura C a norma EN ISO 13349, nel punto di massimo rendimento, alla distanza di 3 metri dal lato aspirazione e si presenta solo per fini comparativi.
Lw: Livello di potenza sonora ottenuto secondo norma ISO 3746. Tolleranza +/- 3 dB(A).

Lp: Sound pressure level measured in free field conditions, propagation hemispherical, measurement category C in accordance with EN ISO 13349, at the point of maximum efficiency at a distance of 3 meters, inlet side (for comparative purposes only).
Lw: Sound power level obtained in accordance with EN ISO 3746. Tolerance +/- 3 dB(A).

AC 400

Cod.	Tipo Type	Modello Model	Ventola Impeller	U	P	P (kW)	In (A)	IP/CL	Mot. (Gr)
1AC0040 / 1AC2040	AC - A/B	402	DY-6-30	T	2	1,1	2,36	55/F	80
1AC0000 / 1AC2000	AC - A/B	404	DY-6-30	M	4	0,12	1,3	55/F	63
1AC0001 / 1AC2001	AC - A/B	404	DY-6-30	T	4	0,12	0,4	55/F	63

Livelli sonori - Sound levels / dB(A)

[Hz]	63	125	250	500	1000	2000	4000	8000	TOT
AC 402 Lw	57	68	73	79	83	83	87	77	90
AC 402 Lp	40	51	56	62	66	66	70	60	73
AC 404 Lw	42	53	58	64	67	68	68	62	74
AC 404 Lp	25	36	41	47	50	51	51	45	56
AC 404 Lw	42	53	58	64	67	68	68	62	74
AC 404 Lp	25	36	41	47	50	51	51	45	56

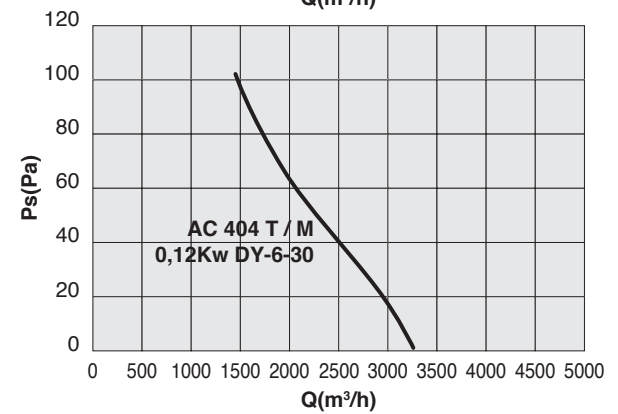
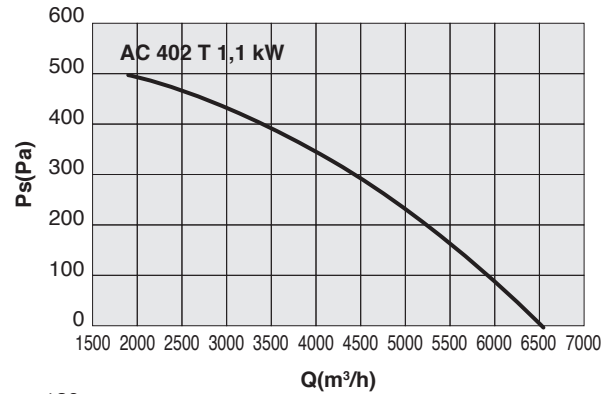

AC 450

Cod.	Tipo Type	Modello Model	Ventola Impeller	U	P	P (kW)	In (A)	IP/CL	Mot. (Gr)
1AC0078 / 1AC2058	AC - A/B	452	DY-6-30	T	2	1,5	3,17	55/F	80
1AC0046 / 1AC2046	AC - A/B	454	DY-6-45	T	4	0,37	1,04	55/F	71

Livelli sonori - Sound levels / dB(A)

[Hz]	63	125	250	500	1000	2000	4000	8000	TOT
AC 452 Lw	62	72	78	85	89	88	88	82	94
AC 452 Lp	45	55	61	68	72	71	71	65	77
AC 454 Lw	50	57	62	67	69	70	70	65	76
AC 454 Lp	33	40	45	50	52	53	53	48	58

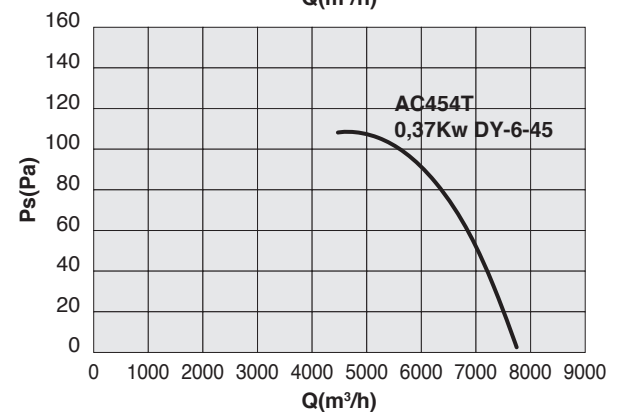
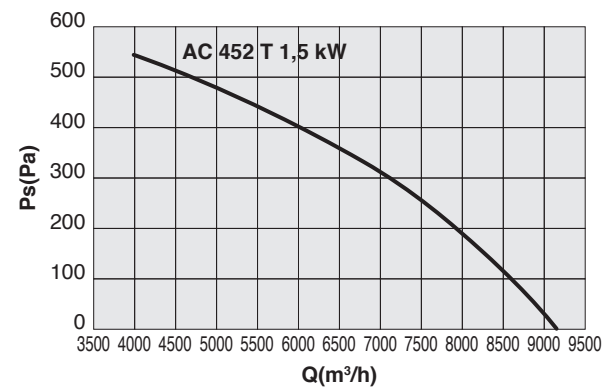

sez. 1.2

Le prestazioni aeruliche sono rilevate in conformità alla norma EN ISO 5801/AMCA 210 con densità dell'aria standard avente peso specifico 1.2 Kg/m³.
 Conformi alla Direttiva ErP 2009/125/CE e al regolamento UE327/2011.
 Categoria di misura: C. Categoria di efficienza: Statica.
 Alimentazione 230V/1Ph/50Hz o 400V/3Ph/50Hz.

Air performances measured according to EN ISO 5801 / AMCA 210 standard with air density with 1.2 kg/m³ specific weight.
 Compliant with ErP 2009/125/EC Directive and EU Regulation 327/2011.
 Measurement category: C. Efficiency category: Static.
 Power supply 230V/1Ph/50Hz or 400V/3Ph/50Hz.

Lp: Livello di pressione sonora rilevato in condizioni di campo libero, propagazione emisferica, categoria di misura C a norma EN ISO 13349, nel punto di massimo rendimento, alla distanza di 3 metri dal lato aspirazione e si presenta solo per fini comparativi.
Lw: Livello di potenza sonora ottenuto secondo norma ISO 3746. Tolleranza +/- 3 dB(A).

Lp: Sound pressure level measured in free field conditions, propagation hemispherical, measurement category C in accordance with EN ISO 13349, at the point of maximum efficiency at a distance of 3 meters, inlet side (for comparative purposes only).
Lw: Sound power level obtained in accordance with EN ISO 3746. Tolerance +/- 3 dB(A).

AC 500

Cod.	Tipo Type	Modello Model	Ventola Impeller	U	P	P (kW)	In (A)	IP/CL	Mot. (Gr)
1AC0079 / 1AC2050	AC - A/B	504	VS-8-30	T	4	0,55	1,47	55/F	80
1AC0003 / 1AC2003	AC - A/B	508	VS-8-35	T	8	0,12	0,71	55/F	71

Livelli sonori - Sound levels / dB(A)

[Hz]	63	125	250	500	1000	2000	4000	8000	TOT
AC 504 Lw	54	65	74	75	76	74	73	63	82
AC 504 Lp	37	48	57	58	59	57	56	46	64
AC 508 Lw	38	45	50	55	58	58	56	50	63
AC 508 Lp	21	28	33	38	41	41	39	33	46

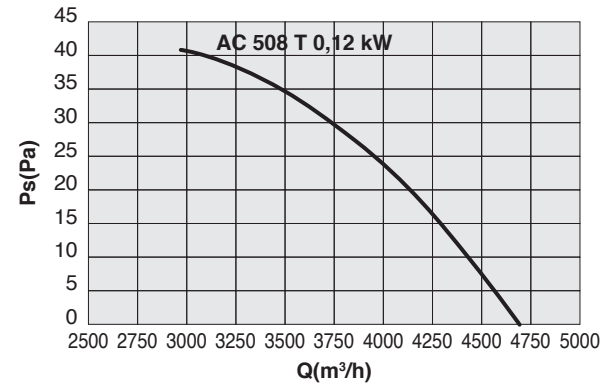
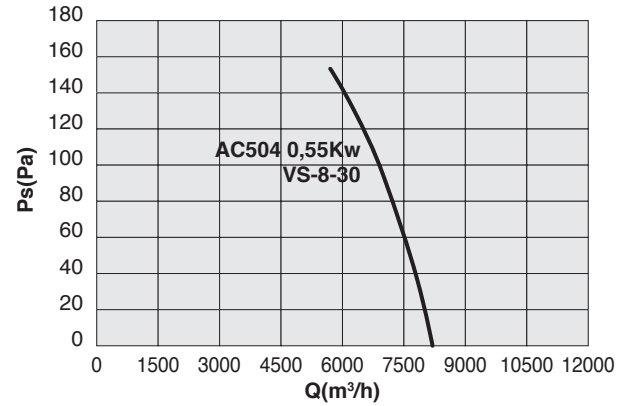

sez.
1.2

Le prestazioni aeruliche sono rilevate in conformità alla norma EN ISO 5801/AMCA 210 con densità dell'aria standard avente peso specifico 1.2 Kg/m³.
Conformi alla Direttiva ErP 2009/125/CE e al regolamento UE327/2011.
Categoria di misura: C. Categoria di efficienza: Statica.
Alimentazione 230V/1Ph/50Hz o 400V/3Ph/50Hz.

Air performances measured according to EN ISO 5801 / AMCA 210 standard with air density with 1.2 kg/m³ specific weight.
Compliant with ErP 2009/125/EC Directive and EU Regulation 327/2011.
Measurement category: C. Efficiency category: Static.
Power supply 230V/1Ph/50Hz or 400V/3Ph/50Hz.

Lp: Livello di pressione sonora rilevato in condizioni di campo libero, propagazione emisferica, categoria di misura C a norma EN ISO 13349, nel punto di massimo rendimento, alla distanza di 3 metri dal lato aspirazione e si presenta solo per fini comparativi.
Lw: Livello di potenza sonora ottenuto secondo norma ISO 3746. Tolleranza +/- 3 dB(A).

Lp: Sound pressure level measured in free field conditions, propagation hemispherical, measurement category C in accordance with EN ISO 13349, at the point of maximum efficiency at a distance of 3 meters, inlet side (for comparative purposes only).
Lw: Sound power level obtained in accordance with EN ISO 3746. Tolerance +/- 3 dB(A).

AC 560

Cod.	Tipo Type	Modello Model	Ventola Impeller	U	P	P (kW)	In (A)	IP/CL	Mot. (Gr)
1AC0065 / 1AC2053	AC - A/B	564	VS-8-30	T	4	0,75	1,99	55/F	80
1AC0007 / 1AC2002	AC - A/B	566	3H-6-45	T	6	0,25	0,87	55/F	71
1AC0004 / 1AC2004	AC - A/B	568	VS-8-35	T	8	0,12	0,71	55/F	71

Livelli sonori - Sound levels / dB(A)

[Hz]	63	125	250	500	1000	2000	4000	8000	TOT
AC 564 Lw	55	62	67	72	75	75	73	67	80
AC 564 Lp	38	45	50	55	58	58	56	50	63
AC 566 Lw	56	63	67	70	70	69	68	62	76
AC 566 Lp	39	46	50	53	53	52	51	45	59
AC 568 Lw	48	55	60	62	63	62	61	55	69
AC 568 Lp	31	38	43	45	46	45	44	38	52

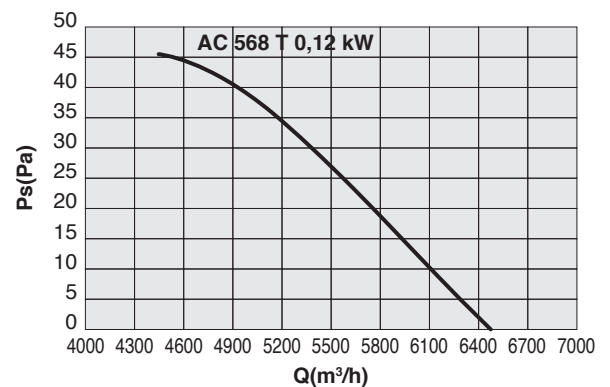
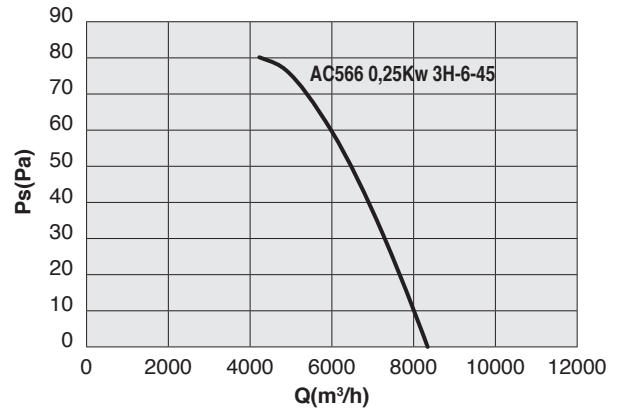
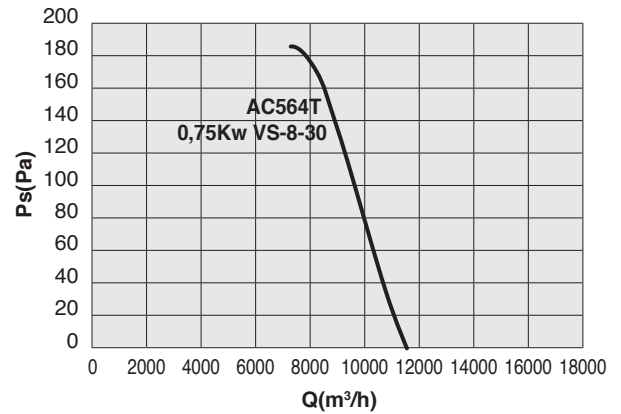

sez. 1.2

Le prestazioni aeruliche sono rilevate in conformità alla norma EN ISO 5801/AMCA 210 con densità dell'aria standard avente peso specifico 1.2 Kg/m³.
Conformi alla Direttiva ErP 2009/125/CE e al regolamento UE327/2011.
Categoria di misura: C. Categoria di efficienza: Statica.
Alimentazione 230V/1Ph/50Hz o 400V/3Ph/50Hz.

Air performances measured according to EN ISO 5801 / AMCA 210 standard with air density with 1.2 kg/m³ specific weight.
Compliant with ErP 2009/125/EC Directive and EU Regulation 327/2011.
Measurement category: C. Efficiency category: Static.
Power supply 230V/1Ph/50Hz or 400V/3Ph/50Hz.

Lp: Livello di pressione sonora rilevato in condizioni di campo libero, propagazione emisferica, categoria di misura C a norma EN ISO 13349, nel punto di massimo rendimento, alla distanza di 3 metri dal lato aspirazione e si presenta solo per fini comparativi.
Lw: Livello di potenza sonora ottenuto secondo norma ISO 3746. Tolleranza +/- 3 dB(A).

Lp: Sound pressure level measured in free field conditions, propagation hemispherical, measurement category C in accordance with EN ISO 13349, at the point of maximum efficiency at a distance of 3 meters, inlet side (for comparative purposes only).
Lw: Sound power level obtained in accordance with EN ISO 3746. Tolerance +/- 3 dB(A).

AC 630

Cod.	Tipo Type	Modello Model	Ventola Impeller	U	P	P (kW)	In (A)	IP/CL	Mot. (Gr)
1AC0088 / 1AC2060	AC - A/B	634	VS-8-30	T	4	1,1	2,5	55/F	90
1AC0005 / 1AC2005	AC - A/B	636	VS-8-35	T	6	0,37	1,2	55/F	80
1AC0006 / 1AC2006	AC - A/B	638	3H-10-45	T	8	0,25	1,1	55/F	80

Livelli sonori - Sound levels / dB(A)

[Hz]	63	125	250	500	1000	2000	4000	8000	TOT
AC 634 Lw	57	64	69	74	77	76	75	69	82
AC 634 Lp	40	47	52	57	60	59	58	52	65
AC 636 Lw	55	62	67	69	70	70	69	63	77
AC 636 Lp	38	45	50	52	53	53	52	46	59
AC 638 Lw	46	56	61	63	65	64	64	58	71
AC 638 Lp	29	39	44	46	48	47	47	41	54

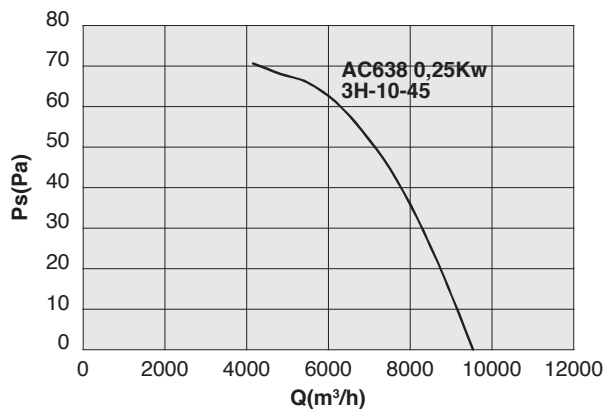
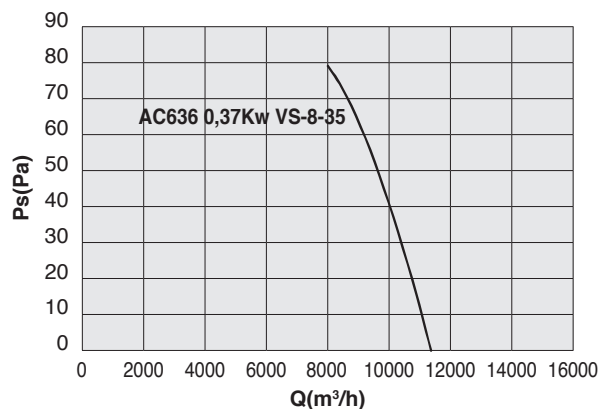
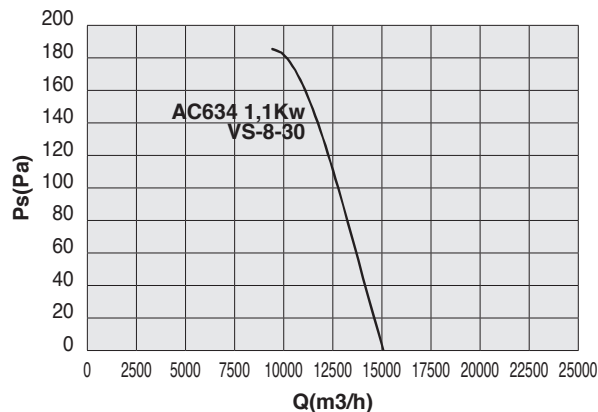

Le prestazioni aerauliche sono rilevate in conformità alla norma EN ISO 5801/AMCA 210 con densità dell'aria standard avente peso specifico 1.2 Kg/m³.
Conformi alla Direttiva ErP 2009/125/CE e al regolamento UE327/2011.
Categoria di misura: C. Categoria di efficienza: Statica.
Alimentazione 230V/1Ph/50Hz o 400V/3Ph/50Hz.

Air performances measured according to EN ISO 5801 / AMCA 210 standard with air density with 1.2 kg/m³ specific weight.
Compliant with ErP 2009/125/EC Directive and EU Regulation 327/2011.
Measurement category: C. Efficiency category: Static.
Power supply 230V/1Ph/50Hz or 400V/3Ph/50Hz.

Lp: Livello di pressione sonora rilevato in condizioni di campo libero, propagazione emisferica, categoria di misura C a norma EN ISO 13349, nel punto di massimo rendimento, alla distanza di 3 metri dal lato aspirazione e si presenta solo per fini comparativi.
Lw: Livello di potenza sonora ottenuto secondo norma ISO 3746. Tolleranza +/- 3 dB(A).

Lp: Sound pressure level measured in free field conditions, propagation hemispherical, measurement category C in accordance with EN ISO 13349, at the point of maximum efficiency at a distance of 3 meters, inlet side (for comparative purposes only).
Lw: Sound power level obtained in accordance with EN ISO 3746. Tolerance +/- 3 dB(A).

AC 710

Cod.	Tipo Type	Modello Model	Ventola Impeller	U	P	P (kW)	In (A)	IP/CL	Mot. (Gr)
1AC0070 / 1AC2070	AC - A/B	714	DY-8-40	T	4	2,2	4,8	55/F	100
1AC0075 / 1AC2075	AC - A/B	716	DY-8-40	T	6	0,75	1,99	55/F	90
1AC0076 / 1AC2076	AC - A/B	718	DY-8-40	T	8	0,37	1,4	55/F	90

Livelli sonori - Sound levels / dB(A)

[Hz]	63	125	250	500	1000	2000	4000	8000	TOT
AC 714 Lw	65	72	77	79	81	81	81	75	87
AC 714 Lp	48	55	60	62	64	64	64	58	70
AC 716 Lw	56	63	68	71	73	72	72	66	79
AC 716 Lp	39	46	51	54	56	55	55	49	62
AC 718 Lw	49	59	64	66	68	67	66	61	74
AC 718 Lp	32	42	47	49	51	50	49	44	57

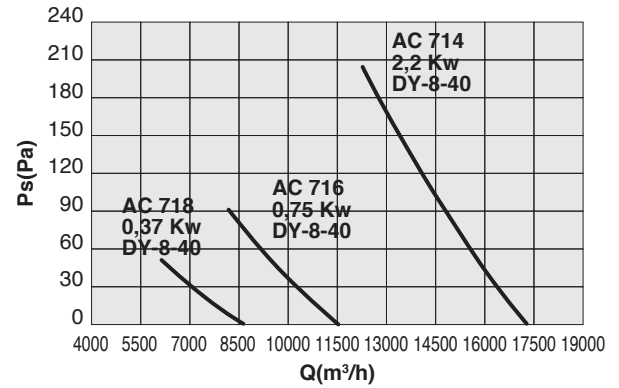

AC 800

Cod.	Tipo Type	Modello Model	Ventola Impeller	U	P	P (kW)	In (A)	IP/CL	Mot. (Gr)
1AC0080 / 1AC2080	AC - A/B	804	VS-10-23	T	4	4	7,75	55/F	112
1AC0081 / 1AC2081	AC - A/B	806	VS-10-23	T	6	1,5	3,91	55/F	100
1AC0087 / 1AC2087	AC - A/B	808	VS-10-23	T	8	0,55	1,9	55/F	90

Livelli sonori - Sound levels / dB(A)

[Hz]	63	125	250	500	1000	2000	4000	8000	TOT
AC 804 Lw	61	71	76	84	86	87	86	80	92
AC 804 Lp	44	54	59	67	69	70	69	63	75
AC 806 Lw	54	64	70	76	78	78	77	70	84
AC 806 Lp	37	47	53	59	61	61	60	53	66
AC 808 Lw	56	67	73	75	73	72	71	64	80
AC 808 Lp	39	50	56	58	56	55	54	47	63

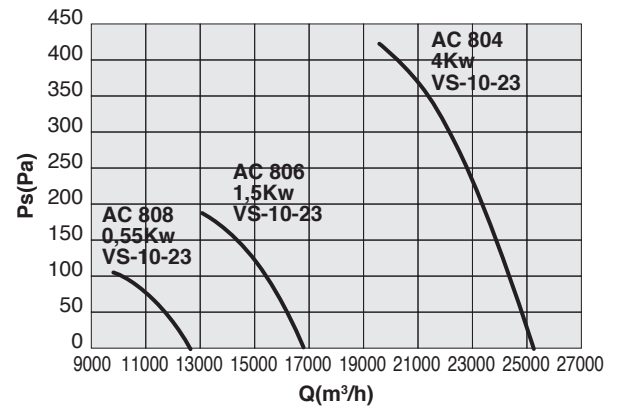

AC 900

Cod.	Tipo Type	Modello Model	Ventola Impeller	U	P	P (kW)	In (A)	IP/CL	Mot. (Gr)
1AC0097 / 1AC2097	AC - A/B	904	VS-10-23	T	4	7,5	14,38	55/F	132
1AC0091 / 1AC2091	AC - A/B	906	VS-10-23	T	6	2,2	4,8	55/F	112
1AC0098 / 1AC2098	AC - A/B	908	VS-10-23	T	8	1,1	3,4	55/F	100

Livelli sonori - Sound levels / dB(A)

[Hz]	63	125	250	500	1000	2000	4000	8000	TOT
AC 904 Lw	65	76	82	88	90	89	88	81	95
AC 904 Lp	48	59	65	71	73	72	71	64	78
AC 906 Lw	58	69	76	79	81	80	78	72	86
AC 906 Lp	41	52	59	62	64	63	61	55	69
AC 908 Lw	57	64	69	72	74	73	72	63	80
AC 908 Lp	40	47	52	55	57	56	55	46	63

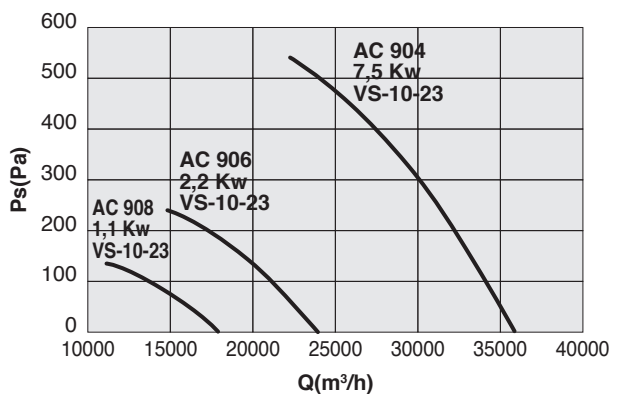

sez. 1.2

Le prestazioni aeruliche sono rilevate in conformit  alla norma EN ISO 5801/AMCA 210 con densit  dell'aria standard avente peso specifico 1.2 Kg/m³.
Conformi alla Direttiva ErP 2009/125/CE e al regolamento UE327/2011.
Categoria di misura: C. Categoria di efficienza: Statica.
Alimentazione 230V/1Ph/50Hz o 400V/3Ph/50Hz.

Air performances measured according to EN ISO 5801 / AMCA 210 standard with air density with 1.2 kg/m³ specific weight.
Compliant with ErP 2009/125/EC Directive and EU Regulation 327/2011.
Measurement category: C. Efficiency category: Static.
Power supply 230V/1Ph/50Hz or 400V/3Ph/50Hz.

Lp: Livello di pressione sonora rilevato in condizioni di campo libero, propagazione emisferica, categoria di misura C a norma EN ISO 13349, nel punto di massimo rendimento, alla distanza di 3 metri dal lato aspirazione e si presenta solo per fini comparativi.
Lw: Livello di potenza sonora ottenuto secondo norma ISO 3746. Tolleranza +/- 3 dB(A).

Lp: Sound pressure level measured in free field conditions, propagation hemispherical, measurement category C in accordance with EN ISO 13349, at the point of maximum efficiency at a distance of 3 meters, inlet side (for comparative purposes only).
Lw: Sound power level obtained in accordance with EN ISO 3746. Tolerance +/- 3 dB(A).

AC 1000

Cod.	Tipo Type	Modello Model	Ventola Impeller	U	P	P (kW)	In (A)	IP/CL	Mot. (Gr)
1AC0102 / 1AC2104	AC - A/B	1004	VS-10-23	T	4	9,2	16,71	55/F	132
1AC0100 / 1AC2100	AC - A/B	1006	VS-10-23	T	6	4	8,85	55/F	132
1AC0101 / 1AC2101	AC - A/B	1008	VS-10-23	T	8	1,5	4,21	55/F	112

Livelli sonori - Sound levels / dB(A)

[Hz]	63	125	250	500	1000	2000	4000	8000	TOT
AC 1004 Lw	68	81	87	91	93	92	90	83	98
AC 1004 Lp	51	64	70	74	76	75	73	66	81
AC 1006 Lw	60	73	79	83	84	83	81	74	90
AC 1006 Lp	43	56	62	66	67	66	64	57	72
AC 1008 Lw	53	65	72	76	78	76	75	68	83
AC 1008 Lp	36	48	55	59	61	59	58	51	65

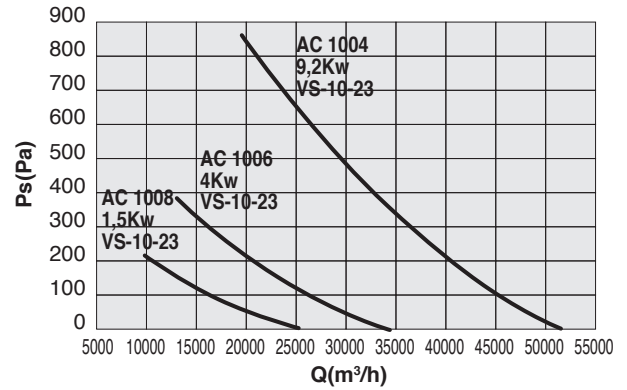

AC 1120

Cod.	Tipo Type	Modello Model	Ventola Impeller	U	P	P (kW)	In (A)	IP/CL	Mot. (Gr)
1AC0112 / 1AC2112	AC - A/B	1126	NH-10-30	T	6	5,5	11,8	55/F	132
1AC0113 / 1AC2113	AC - A/B	1128	NH-10-30	T	8	2,2	5,5	55/F	132

Livelli sonori - Sound levels / dB(A)

[Hz]	63	125	250	500	1000	2000	4000	8000	TOT
AC 1126 Lw	71	78	84	86	88	86	84	75	93
AC 1126 Lp	54	61	67	69	71	69	67	58	76
AC 1128 Lw	64	76	85	83	83	80	78	69	90
AC 1128 Lp	47	59	68	66	66	63	61	52	73

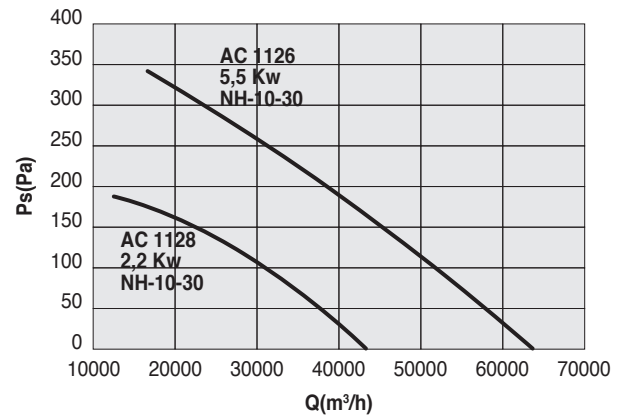

AC 1250

Cod.	Tipo Type	Modello Model	Ventola Impeller	U	P	P (kW)	In (A)	IP/CL	Mot. (Gr)
1AC0125 / 1AC2125	AC - A/B	1256	NH-10-30	T	6	7,5	15,2	55/F	160
1AC0126 / 1AC2126	AC - A/B	1258	NH-10-30	T	8	3	7,3	55/F	132

Livelli sonori - Sound levels / dB(A)

[Hz]	63	125	250	500	1000	2000	4000	8000	TOT
CC 1256 Lw	71	79	85	89	92	91	90	85	97
CC 1256 Lp	54	62	68	72	75	74	73	68	80
CC 1258 Lw	62	69	75	81	84	84	83	77	90
CC 1258 Lp	45	52	58	64	67	67	66	60	73

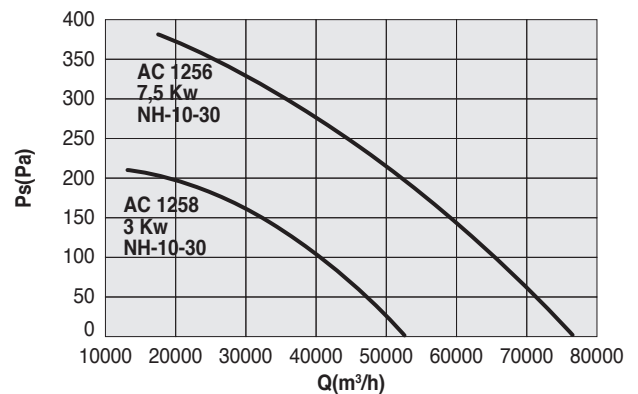

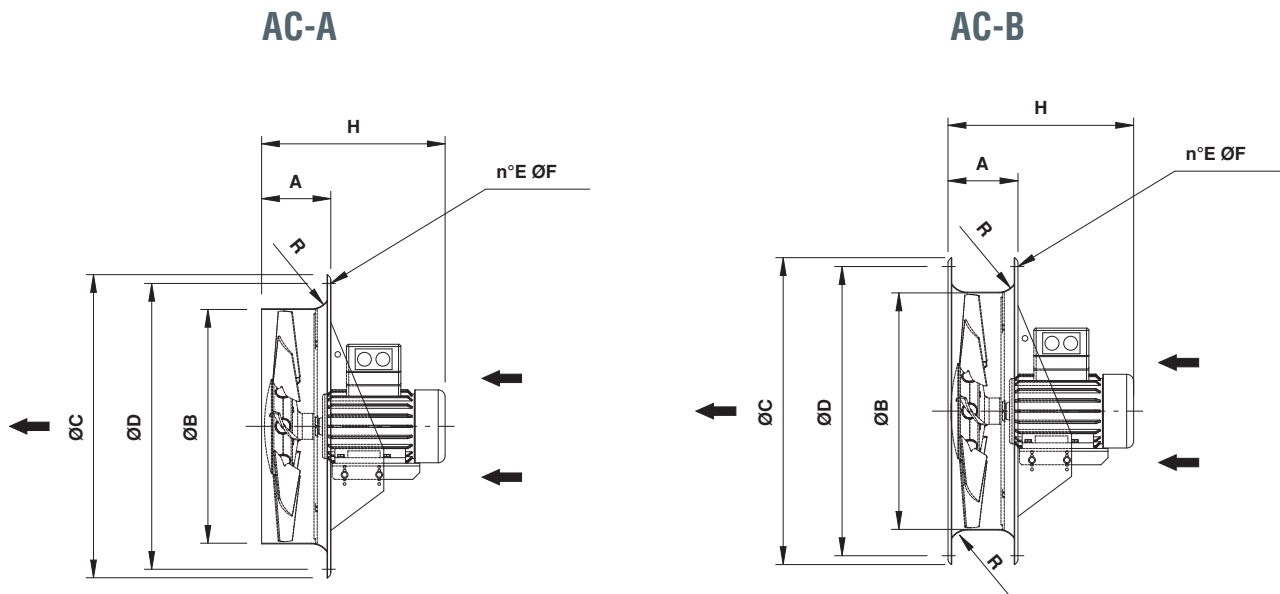

TIPO / TYPE	A	B	C	R	D	E	F	H	kg*
AC 310	175	307	442	35	395	8	10	300	12
AC 350	175	357	492	35	450	8	12	320	15
AC 400	175	407	546	35	500	8	12	380	17
AC 450	175	457	598	40	560	12	12	390	23
AC 500	190	507	658	40	620	12	12	420	25
AC 560	190	567	730	50	690	12	12	450	28
AC 630	190	637	810	50	770	16	12	470	35
AC 710	230	708	910	70	860	16	12	500	45
AC 800	250	808	1025	70	970	16	16	550	53
AC 900	300	910	1125	70	1070	16	16	660	70
AC 1000	300	1010	1245	70	1190	20	16	700	105
AC 1120	300	1130	1380	85	1320	20	16	720	118
AC 1250	300	1260	1525	85	1470	20	16	750	150

Dimensioni in mm / *Dimensions in mm*

* Pesi indicativi / *Indicative weights*

RETI PROTEZIONE CCr *PROTECTION GUARDS CCr*

Salvaguardano dal contatto accidentale con le parti in movimento del ventilatore. Realizzate in filo d'acciaio, a norma UNI 12499 e protette contro gli agenti atmosferici. CCr: versione piana.

They prevent from casual contact with moving parts of the fan. Manufactured in steel rod according to UNI 12499 standard and protected against atmospheric agents. CCr: flat version.

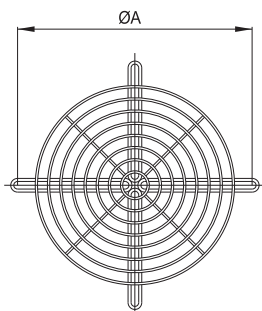

Cod.	TIPO / TYPE	ØA	kg
5RE9035	CCr x AC - B 31	395	0,6
5RE9040	CCr x AC - B 35	450	0,7
5RE9045	CCr x AC - B 40	500	1
5RE9050	CCr x AC - B 45	560	1,4
5RE9056	CCr x AC - B 50	620	2
5RE9063	CCr x AC - B 56	690	2,2
5RE9071	CCr x AC - B 63	770	2,7
5RE9080	CCr x AC - B 71	860	4
5RE9090	CCr x AC - B 80	970	5
5RE9100	CCr x AC - B 90	1070	5
5RE9102	CCr x AC - B 100	1190	6
5RE9105	CCr x AC - B 112	1320	9
5RE9110	CCr x AC - B 125	1470	12

PIASTRA FISSAGGIO *FIXING PLATE*

Facilita l'installazione a parete - *Eases the wall installation*

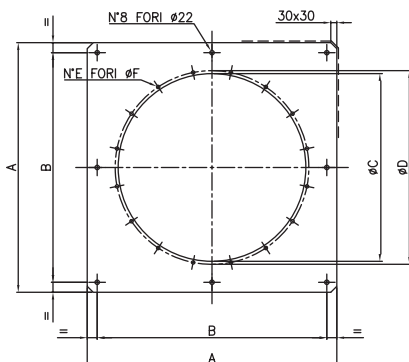

Cod.	TIPO / TYPE	A	B	ØC	ØD	E	ØF	Sp	kg
5PP0035	35	750	650	420	450	8	13	30/10	10
5PP0041	40	750	650	470	500	8	13	30/10	9
5PP0071	71	1120	1020	830	860	16	13	40/10	22
5PP0080	80	1210	1110	940	970	16	17	40/10	24
5PP0090	90	1320	1210	1040	1070	16	17	40/10	28
5PP2010	100	1420	1320	1140	1190	20	17	50/10	39
5PP0112	112	1570	1470	1270	1320	20	17	50/10	47
5PP0125	125	1720	1620	1420	1470	20	17	50/10	54