

> AL-ATX

Ventilatori centrifughi pale avanti

Forward curved blade centrifugal fans

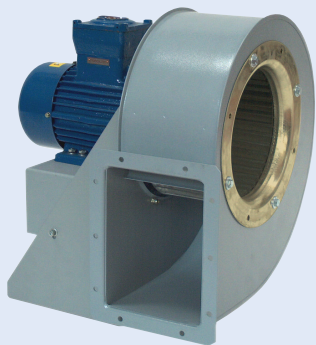

Certificato / *Certificate*
IMQ 10 ATEX 017 X

DESCRIZIONE GENERALE

I ventilatori centrifughi della serie AL-ATX sono costruiti e certificati in conformità alla Direttiva ATEX 2014/34/UE ed il loro impiego è previsto con aria pulita con temperatura da -20°C a +40°C. Sono adatti all'installazione in zona 1/21, cioè in aree o ambienti dove sia necessario garantire un elevato fattore di sicurezza contro le esplosioni, dovuti a gas (I12G) o polveri infiammabili (I12D). La loro costruzione è certificata da IMQ secondo la EN 14986/2017 (Certificato IMQ 10 ATEX 017 X). Trovano il loro impiego in tutte quelle applicazioni industriali dove siano richiesti piccoli volumi d'aria con alte pressioni. La serie è costituita da modelli con diametro girante da 200 a 450 mm. Il motore è direttamente accoppiato alla girante del tipo pale avanti. La cassa è facilmente orientabile, anche in sito, ogni 45°, esclusi gli orientamenti 180° e 225° che richiedono una costruzione speciale.

CONSTRUZIONE

- Cassa a spirale realizzata in lamiera d'acciaio. Protetta contro gli agenti atmosferici con vernici a polveri epossipoliesteriche.
- Girante a semplice aspirazione, con pale curve in avanti (sirocco), a spessore costante, realizzata in lamiera zincata dal tipo 200 al 315 e in lamiera d'acciaio con pale saldate e verniciate dal tipo 355 al 450.
- Boccaglio in ottone su modelli con esecuzione I1B+H₂ e lamiera verniciata su modelli con esecuzione I1B.
- Esecuzione 4 (accoppiamento diretto con girante a sbalzo e motore sostenuto da supporto).
- Orientamento standard LG 270°.

MOTORIZZAZIONI

- Motore asincrono trifase o monofase a norme internazionali IEC 60034, IEC 60072, IEC 60079 e/o IEC 61241, EMC 2004/108/CE, LVD 2006/95/CE, con certificati ATEX per atmosfere esplosive Categoria G gruppo II classe termica T4 protezione Exd e marcatura CE, IP 55/IP 65, classe F. Idonei ad un servizio S1 (funzionamento continuo a carico costante).

ACCESSORI

- Rete di protezione per bocca aspirante e premente realizzata a norma UNI 12499 e protetta contro gli agenti atmosferici.
- Raccordo aspirante, realizzato in lamiera protetta dagli agenti atmosferici.

A RICHIESTA

- Motori a doppia polarità.
- Versioni con temperatura d'esercizio diverse.
- Versioni con motori per atmosfere diverse.
- Versioni con motori idonei alla regolazione della velocità.

INSTALLAZIONE

I ventilatori centrifughi con girante a pale curve in avanti devono sempre funzionare collegati a tubazioni o prevedere sistemi, che con la loro resistenza (ad esempio serrande di taratura), ne limitino la portata in modo tale che i valori di corrente assorbita rientrino nei valori ammissibili riportati sulla targa del motore elettrico.

GENERAL DESCRIPTION

The centrifugal fans of the AL-ATX series are designed and constructed to operate in potentially explosive environments, according to the ATEX Directive 2014/34/UE. They are suitable to convey clean air in the temperature range of -20°C +40°C. They are suitable for installation in zone 1/21, that are areas where it is necessary to guarantee high security against explosions and fires due to the presence of flammable gas (I12G) or dusts (I12D). These fans are certified by IMQ according to ATEX Directive 94/9/CE and to EN 14986/2017 (Certificate IMQ 10 ATEX 017 X). They are suitable for all the industrial applications where small air volumes and high pressures are required. The series consists of different models with impeller diameter from 200 to 450 mm. The motor is directly fitted to the forward curved impeller. The casing is easily adjustable, also on site, to the required discharge angle every 45°, excluding orientations 180° and 225° which require a special construction.

CONSTRUCTION

- Volute casing in folded steel sheet, protected against atmospheric agent by epoxy paint.
- Single inlet, single width, forward curved impeller (sirocco type), manufactured in galvanized steel sheet from type 200 to 315 and in steel sheet with welded blades epoxy painted from type 355 to 450.
- Brass inlet on models gauge execution I1B+H₂ and steel sheet with epoxy finish on models I1B.
- Execution 4 (with impeller directly coupled to motor).
- Standard orientation LG 270°.

MOTOR

- Asynchronous three-phase motors or single-phase according to international standards IEC 60034, IEC 60072, IEC 60079 and/or IEC61241, EMC 2004/108/CE, LVD 2006/95/CE, with ATEX certification for explosive atmospheres category G group II thermal class T4 protection Exd, CE marked, IP55/IP 65, class F. Suitable to S1 service (continuous working at constant load).

ACCESSORIES







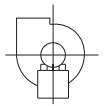

- Inlet and outlet protection guard manufactured according to UNI 12499 norm and protected against the atmospheric agents.
- Round inlet cone, in steel sheet epoxy coated.

UPON REQUEST

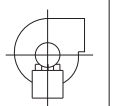
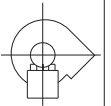
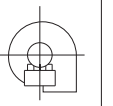
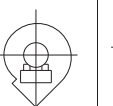
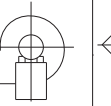
- Double polarity motors.
- Versions with different temperature ranges.
- Versions with motors for different atmospheres.
- Versions with motors suitable for speed regulation.

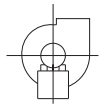
INSTALLATION

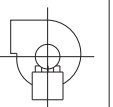
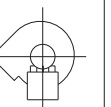
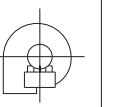
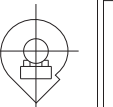
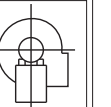
The centrifugal fans with forward curved impellers must always be installed to ducted systems, eventually with the use of additional resistance (for example setting shutters), that can limit the air flow in such a way that the absorbed current is within the acceptable values stated on the motor rating label.

Rotazione <i>Rotation</i> RD								
Forma/Form	0°	45°	90°	135°	180°	225°	270°	315°
Rotazione <i>Rotation</i> LG								

N.B.: Orientamento standard LG270°
Standard discharge angles LG 270°

PRESTAZIONI *Performance*

AL-ATX

Le prestazioni aeruliche sono rilevate in conformità alla norma EN ISO 5801/AMCA 210 con densità dell'aria standard avente peso specifico 1,2 kg/m³. Alimentazione 400V/3Ph/50Hz.

Lp: Livello di pressione sonora rilevato in condizioni di campo libero, propagazione sferica, categoria di misura D a norma EN ISO 13349, nel punto di massimo rendimento, alla distanza di 1,5 metri irradiato e si presenta solo per fini comparativi.
Lw: Livello di potenza sonora ottenuto secondo norma ISO 3746. Tolleranza +/- 3 dB(A).

Air performances measured according to EN ISO 5801 / AMCA 210 standard with air density with 1.2 kg/m³ specific weight. Power supply 400V/3Ph/50Hz.

Lp: Sound pressure level measured in free field conditions, propagation spherical, measurement category D in accordance with EN ISO 13349, at the point of maximum efficiency, at a distance of 1.5 meters (for comparative purposes only).
Lw: Sound power level obtained in accordance with EN ISO 3746. Tolerance +/- 3 dB(A).

AL-ATX 200

Cod.	Tipo Type	Modello Model	U	P	Pm (kW)	In (A)	IP/CL	Mot (GR.)
1XA2000	AL - ATX	200/2	T	2	1,10	2,40	55/F	80
1XA2001	AL - ATX	200/4	T	4	0,25	1,00	55/F	71

Limiti d'impiego - *Operational limit*

Tipo Type	Modello Model	Q max (m³/h)	Pt min (Pa)	C max (m/s)	S (m²)	Pd² (kgm²)
AL	200/2	1700	1050	19,43	0,0243	0,02
AL	200/4	1550	211	17,72	0,0243	0,02

Livelli sonori - *Sound levels / dB(A)*

[Hz]	62,5	125	250	500	1000	2000	4000	8000	TOT
AL 200/2 Lw	67	79	85	88	90	89	78	68	95
AL 200/2 Lp	56	68	74	77	79	78	67	57	84
AL 200/4 Lw	51	63	68	72	77	70	62	52	79
AL 200/4 Lp	40	52	57	61	66	59	51	41	68

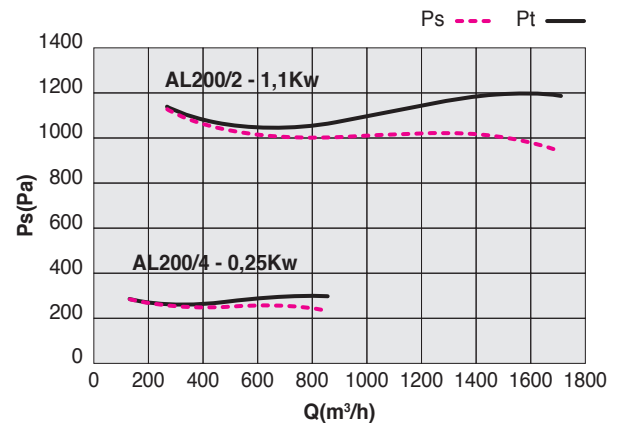

AL 225

Cod.	Tipo Type	Modello Model	U	P	Pm (kW)	In (A)	IP/CL	Mot (GR.)
1XA2200	AL - ATX	225/2	T	2	2,20	4,80	55/F	90
1XA2201	AL - ATX	225/4	T	4	0,55	1,50	55/F	80

Limiti d'impiego - *Operational limit*

Tipo Type	Modello Model	Q max (m³/h)	Pt min (Pa)	C max (m/s)	S (m²)	Pd² (kgm²)
AL	225/2	2720	1382	24,37	0,031	0,032
AL	225/4	1950	329	17,47	0,031	0,032

Livelli sonori - *Sound levels / dB(A)*

[Hz]	62,5	125	250	500	1000	2000	4000	8000	TOT
AL 225/2 Lw	67	79	85	88	90	89	78	68	95
AL 225/2 Lp	56	68	74	77	79	78	67	57	84
AL 225/4 Lw	51	63	69	72	77	70	62	52	79
AL 225/4 Lp	40	52	58	61	66	58	51	41	68

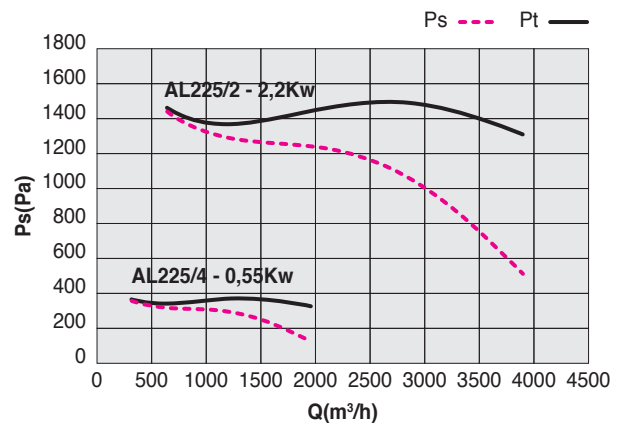

Le prestazioni aerauliche sono rilevate in conformità alla norma EN ISO 5801/AMCA 210 con densità dell'aria standard avente peso specifico 1,2 kg/m³. Alimentazione 400V/3Ph/50Hz.

Air performances measured according to EN ISO 5801 / AMCA 210 standard with air density with 1.2 kg/m³ specific weight. Power supply 400V/3Ph/50Hz.

Lp: Livello di pressione sonora rilevato in condizioni di campo libero, propagazione sferica, categoria di misura D a norma EN ISO 13349, nel punto di massimo rendimento, alla distanza di 1,5 metri irradiato e si presenta solo per fini comparativi.

Lp: Sound pressure level measured in free field conditions, propagation spherical, measurement category D in accordance with EN ISO 13349, at the point of maximum efficiency, at a distance of 1.5 meters (for comparative purposes only).

Lw: Livello di potenza sonora ottenuto secondo norma ISO 3746. Tolleranza +/- 3 dB(A).

Lw: Sound power level obtained in accordance with EN ISO 3746. Tolerance +/- 3 dB(A).

AL-ATX 250

Cod.	Tipo Type	Modello Model	U	P	Pm (kW)	In (A)	IP/CL	Mot (GR.)
1XA2500	AL - ATX	250/2	T	2	3,00	6,50	55/F	100
1XA2501	AL - ATX	250/4	T	4	0,75	2,00	55/F	80
1XA2502	AL - ATX	250/6	T	6	0,37	1,40	55/F	80

Limiti d'impiego - Operational limit

Tipo Type	Modello Model	Q max (m ³ /h)	Pt min (Pa)	C max (m/s)	S (m ²)	Pd ² (kgm ²)
AL	250/2	2920	472	21,10	0,0385	0,072
AL	250/4	2450	371	17,68	0,0385	0,072
AL	250/6	1930	124	13,925	0,0385	0,072

Livelli sonori - Sound levels / dB(A)

[Hz]	62,5	125	250	500	1000	2000	4000	8000	TOT
AL 250/4 Lw	53	65	71	74	79	72	64	54	81
AL 250/4 Lp	42	54	60	63	68	61	53	43	70
AL 250/6 Lw	44	56	61	68	67	63	55	45	71
AL 250/6 Lp	33	45	50	57	56	52	44	34	61

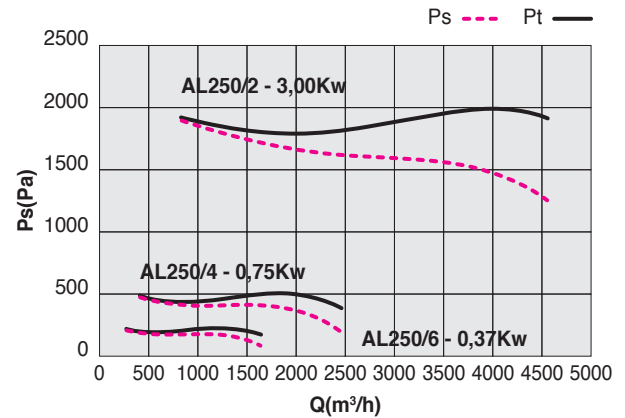

AL-ATX 280

Cod.	Tipo Type	Modello Model	U	P	Pm (kW)	In (A)	IP/CL	Mot (GR.)
1XA2801	AL - ATX	280/4 A	T	4	1,50	3,80	55/F	90
1XA2800	AL - ATX	280/4 B	T	4	1,10	2,80	55/F	90
1XA2802	AL - ATX	280/6	T	6	0,75	2,20	55/F	90

Limiti d'impiego - Operational limit

Tipo Type	Modello Model	Q max (m ³ /h)	Pt min (Pa)	C max (m/s)	S (m ²)	Pd ² (kgm ²)
AL	280/4	3540	452	19,39	0,0507	0,12
AL	280/6	2820	174	15,45	0,0507	0,12

Livelli sonori - Sound levels / dB(A)

[Hz]	62,5	125	250	500	1000	2000	4000	8000	TOT
AL 280/4 Lw	53	65	71	74	79	72	64	54	81
AL 280/4 Lp	42	54	60	63	68	61	53	43	70
AL 280/6 Lw	47	59	65	71	70	66	58	48	75
AL 280/6 Lp	36	48	54	60	59	55	47	37	64

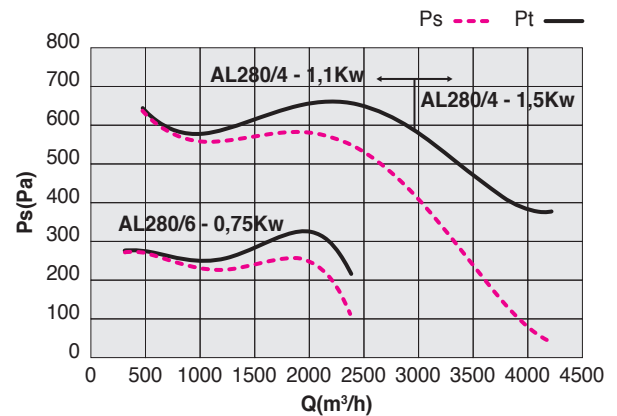

Le prestazioni aerauliche sono rilevate in conformità alla norma EN ISO 5801/AMCA 210 con densità dell'aria standard avente peso specifico 1,2 kg/m³. Alimentazione 400V/3Ph/50Hz.

Air performances measured according to EN ISO 5801 / AMCA 210 standard with air density with 1.2 kg/m³ specific weight. Power supply 400V/3Ph/50Hz.

Lp: Livello di pressione sonora rilevato in condizioni di campo libero, propagazione sferica, categoria di misura D a norma EN ISO 13349, nel punto di massimo rendimento, alla distanza di 1,5 metri irradiato e si presenta solo per fini comparativi.
Lw: Livello di potenza sonora ottenuto secondo norma ISO 3746. Tolleranza +/- 3 dB(A).

Lp: Sound pressure level measured in free field conditions, propagation spherical, measurement category D in accordance with EN ISO 13349, at the point of maximum efficiency, at a distance of 1.5 meters (for comparative purposes only).
Lw: Sound power level obtained in accordance with EN ISO 3746. Tolerance +/- 3 dB(A).

AL 315

Cod.	Tipo Type	Modello Model	U	P	Pm (kW)	In (A)	IP/CL	Mot (GR.)
1XA3101	AL - ATX	315/4 A	T	4	3,00	6,60	55/F	100
1XA3100	AL - ATX	315/4 B	T	4	2,20	4,80	55/F	100
1XA3102	AL - ATX	315/6	T	6	1,10	3,20	55/F	90

Limiti d'impiego - Operational limit

Tipo Type	Modello Model	Q max (m ³ /h)	Pt min (Pa)	C max (m/s)	S (m ²)	Pd ² (kgm ²)
AL	315/4	5760	482	24,81	0,0645	0,20
AL	315/6	4200	195	18,09	0,0645	0,20

Livelli sonori - Sound levels / dB(A)

[Hz]	62,5	125	250	500	1000	2000	4000	8000	TOT
AL 315/4 Lw	60	72	78	81	86	79	71	61	88
AL 315/4 Lp	49	61	67	70	75	68	60	50	77
AL 315/6 Lw	50	62	68	74	73	69	61	51	78
AL 315/6 Lp	39	51	57	63	62	58	50	40	67

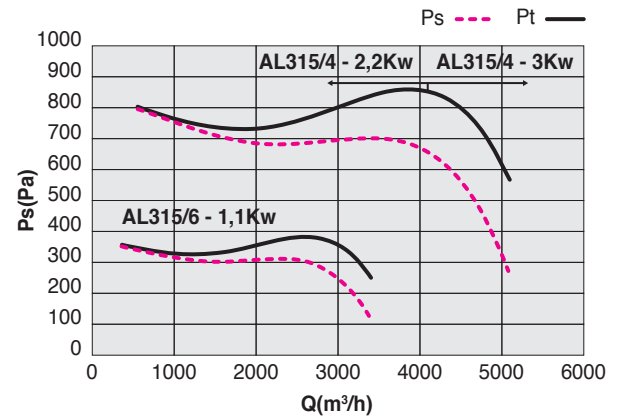

AL 355

Cod.	Tipo Type	Modello Model	U	P	Pm (kW)	In (A)	IP/CL	Mot (GR.)
1XA3501	AL - ATX	355/4 A	T	4	4,00	8,70	55/F	112
1XA3500	AL - ATX	355/4 B	T	4	3,00	6,60	55/F	100
1XA3502	AL - ATX	355/6	T	6	1,50	3,90	55/F	100
1XA3503	AL - ATX	355/8	T	8	0,75	2,60	55/F	100

Limiti d'impiego - Operational limit

Tipo Type	Modello Model	Q max (m ³ /h)	Pt min (Pa)	C max (m/s)	S (m ²)	Pd ² (kgm ²)
AL	355/4 - A	7660	425	24,69	0,08616	0,71
AL	355/6	5030	197	16,22	0,08616	0,71
AL	355/4 - B	6715	500	21,65	0,08616	0,71
AL	355/8	3680	90	11,86	0,08616	0,71

Livelli sonori - Sound levels / dB(A)

[Hz]	62,5	125	250	500	1000	2000	4000	8000	TOT
AL 355/4 Lw	66	78	83	87	92	85	77	67	94
AL 355/4 Lp	55	67	72	76	81	74	66	56	83
AL 355/6 Lw	56	68	74	80	79	75	67	57	84
AL 355/6 Lp	45	57	63	69	68	64	56	46	73

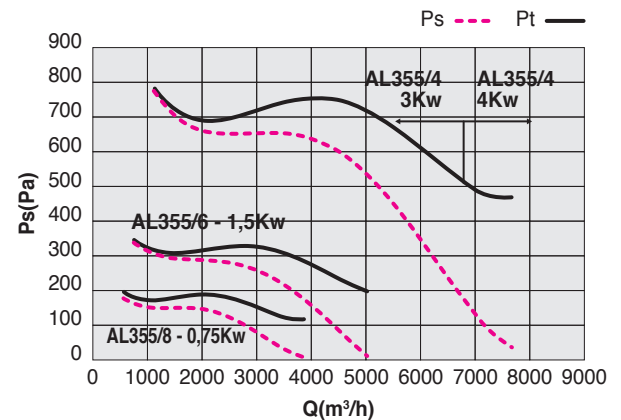

Le prestazioni aerauliche sono rilevate in conformità alla norma EN ISO 5801/AMCA 210 con densità dell'aria standard avente peso specifico 1,2 kg/m³. Alimentazione 400V/3Ph/50Hz.

Air performances measured according to EN ISO 5801 / AMCA 210 standard with air density with 1.2 kg/m³ specific weight. Power supply 400V/3Ph/50Hz.

Lp: Livello di pressione sonora rilevato in condizioni di campo libero, propagazione sferica, categoria di misura D a norma EN ISO 13349, nel punto di massimo rendimento, alla distanza di 1,5 metri irradiato e si presenta solo per fini comparativi.

Lp: Sound pressure level measured in free field conditions, propagation spherical, measurement category D in accordance with EN ISO 13349, at the point of maximum efficiency, at a distance of 1.5 meters (for comparative purposes only).

Lw: Livello di potenza sonora ottenuto secondo norma ISO 3746. Tolleranza +/- 3 dB(A).

Lw: Sound power level obtained in accordance with EN ISO 3746. Tolerance +/- 3 dB(A).

AL 400

Cod.	Tipo Type	Modello Model	U	P	Pm (kW)	In (A)	IP/CL	Mot (GR.)
1XA4001	AL - ATX	400/4 A	T	4	7,50	14,80	55/F	132
1XA4000	AL - ATX	400/4 B	T	4	5,50	11,40	55/F	132
1XA4002	AL - ATX	400/6	T	6	2,20	4,90	55/F	112
1XA4003	AL - ATX	400/8	T	8	1,10	3,60	55/F	100

Limiti d'impiego - Operational limit

Tipo Type	Modello Model	Q max (m ³ /h)	Pt min (Pa)	C max (m/s)	S (m ²)	Pd ² (kgm ²)
AL	400/4 A	9300	250	24,84	0,104	1,40
AL	400/4 B	5850	1115	15,63	0,104	1,40
AL	400/6	6290	325	16,80	0,104	1,40
AL	400/8	4720	185	12,61	0,104	1,40

Livelli sonori - Sound levels / dB(A)

[Hz]	62,5	125	250	500	1000	2000	4000	8000	TOT
AL 400/4 A Lw	68	80	85	89	94	87	79	69	96
AL 400/4 A Lp	54	66	71	75	80	73	65	55	82
AL 400/4 B Lw	67	79	84	88	93	86	78	68	95
AL 400/4 B Lp	53	65	70	74	79	72	64	54	81
AL 400/6 Lw	58	70	76	82	81	77	69	59	86
AL 400/6 Lp	44	56	62	68	67	63	55	45	72
AL 400/8 Lw	51	63	72	72	74	70	62	52	78
AL 400/8 Lp	37	49	58	58	60	56	48	38	64

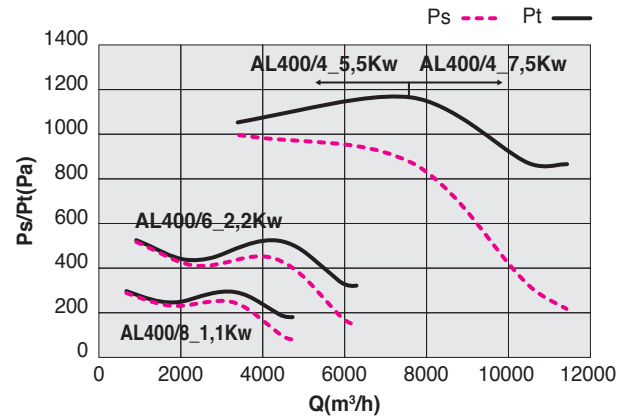

AL 450

Cod.	Tipo Type	Modello Model	U	P	Pm (kW)	In (A)	IP/CL	Mot (GR.)
1XA4503	AL - ATX	450/4	T	4	9,00	17,90	55/F	132
1XA4501	AL - ATX	450/6	T	6	4,00	9,10	55/F	132
1XA4502	AL - ATX	450/8	T	8	2,20	5,20	55/F	132

Limiti d'impiego - Operational limit

Tipo Type	Modello Model	Q max (m ³ /h)	Pt min (Pa)	C max (m/s)	S (m ²)	Pd ² (kgm ²)
AL	450/4	10770	1200	23,01	0,13	2,92
AL	450/6	7140	355	15,26	0,13	2,92
AL	450/8	5450	200	11,63	0,13	2,92

Livelli sonori - Sound levels / dB(A)

[Hz]	62,5	125	250	500	1000	2000	4000	8000	TOT
AL 450/4 Lw	71	83	89	92	97	90	82	71	100
AL 450/4 Lp	57	69	75	78	83	76	68	58	86
AL 450/6 Lw	62	74	80	86	85	81	73	63	90
AL 450/6 Lp	48	60	66	72	71	67	59	49	76
AL 450/8 Lw	55	67	76	76	78	74	66	56	82
AL 450/8 Lp	41	53	62	62	64	60	52	42	68

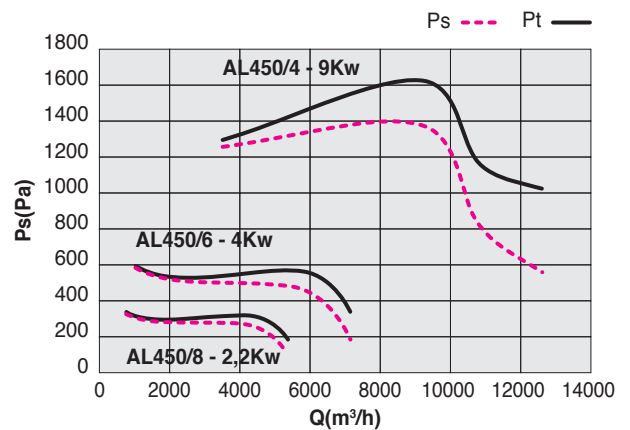

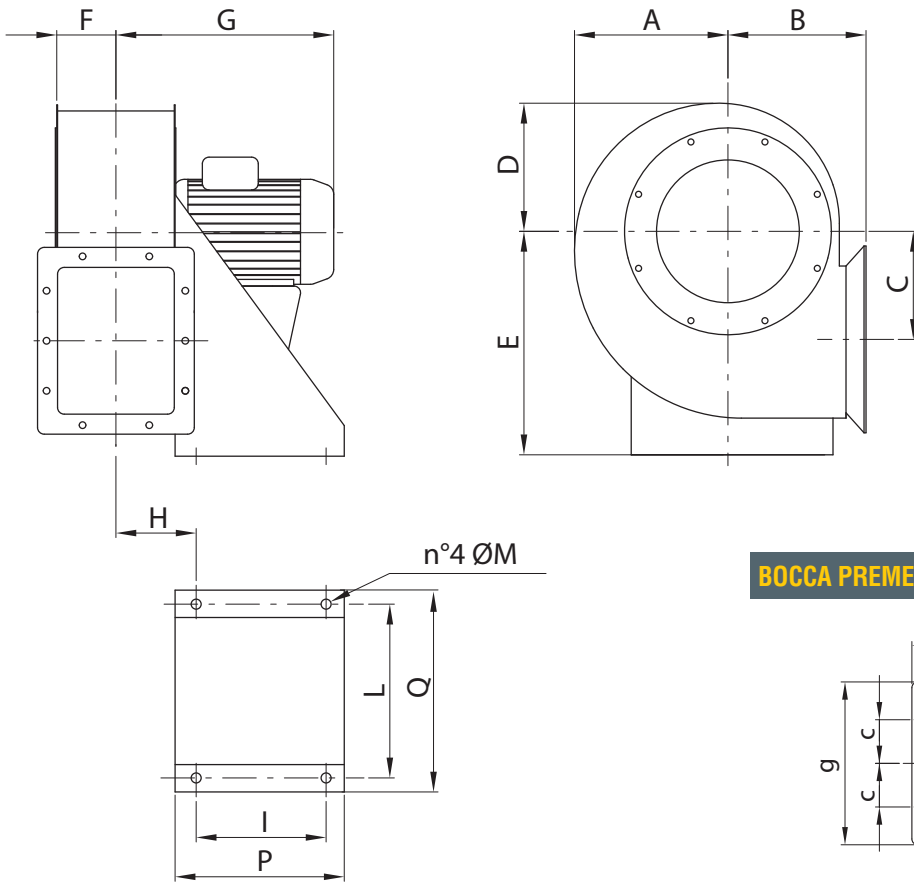

BOCCA PREMENTE / OUT LET

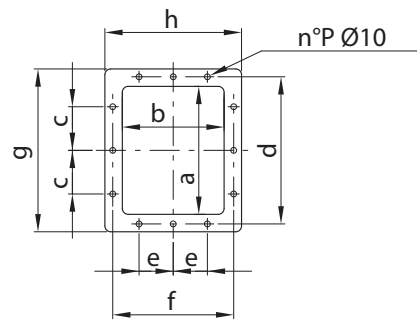

BOCCA ASPIRANTE / INLET

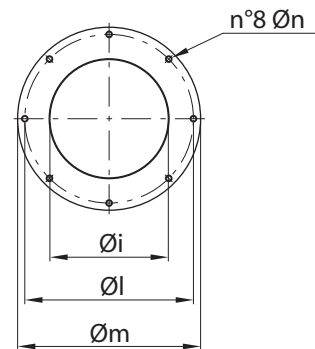

TIPO / TYPE	A	B	C	D	E	F	G	H	I	L	M	a	b	c	d	e	f	g	h	i	l	m	n	P	kg
AL-ATX 200	183	173	120	156	280	70	340	100	140	218	12	180	135	75	213	100	168	240	195	166	235	255	M8	10	20
AL-ATX 225	210	190	142	175	310	80	380	110	140	218	12	200	155	75	233	100	188	260	215	189	260	280	M8	10	32
AL-ATX 250	231	207	162	193	335	90	440	120	205	270	12	220	175	75	253	100	208	280	235	212	290	310	M8	10	39
AL-ATX 280	257	227	170	216	365	100	420	130	205	270	12	260	195	100	293	125	228	320	255	242	310	340	M9,5	10	40
AL-ATX 315	288	250	192	244	405	110	460	140	205	319	12	300	215	100	333	150	248	360	275	277	335	375	M9,5	10	55
AL-ATX 355	321	272	212	270	445	123	490	153	245	354	15	340	240	125	373	100	273	400	300	304	395	425	M9,5	12	73
AL-ATX 400	358	300	235	301	505	138	600	168	245	370	15	385	270	125	425	100	310	465	350	354	445	465	M9,5	12	123
AL-ATX 450	406	334	267	337	560	153	590	183	340	439	15	430	300	150	470	100	340	510	380	404	490	520	M9,5	12	146

Dimensioni in mm / Dimensions in mm

NB: accessori non contemplati nel **Certificato di Esame del Tipo**. Contattare il servizio tecnico-commerciale per esigenze costruttive diverse.
NB: accessories not included in the **Type Examination Certificate**. Please contact us for any different construction requirements.

RACCORDO ASPIRANTE / ROUND INLET ADAPTER

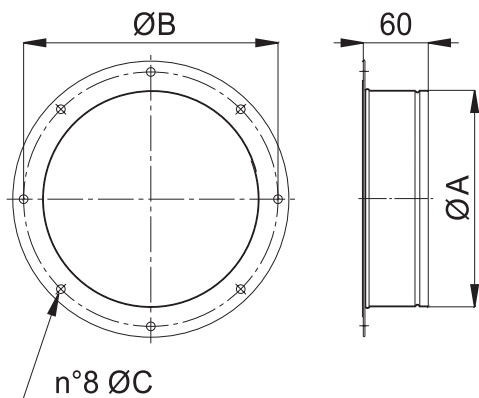

COD.	TIPO TYPE	A	B	C	kg
5B02100	200	200	235	8	0,5
5B02202	225	200	260	8	0,6
5B02601	250	250	290	8	0,7
5B02801	280	250	310	9,5	0,8
5B08319	315	315	355	9,5	1
5B08361	355	350	395	9,5	1
5B08403	400	400	445	9,5	1,2
5B08600	455	450	490	9,5	1,3

Dimensioni in mm / Dimensions in mm
 Pesì indicativi / Indicative weights

RETE BOCCA PREMENTE / OUTLET GUARD

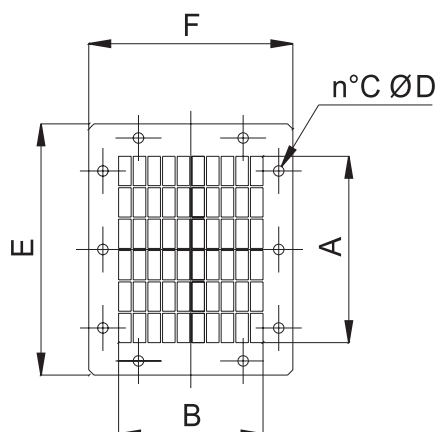

COD.	TIPO TYPE	A	B	C	D	E	F	kg
5RE7500	200	169	136	10	10	240	195	0,7
5RE7505	225	198	164	10	10	260	215	0,8
5RE7510	250	227	178	10	10	280	235	1,0
5RE7515	280	256	192	10	10	320	255	1,2
5RE7520	315	285	220	10	10	360	275	1,4
5RE7525	355	343	248	12	10	400	300	1,6
5RE7530	400	401	276	12	10	465	350	2,2
5RE7535	455	430	304	12	10	510	380	2,6

Dimensioni in mm / Dimensions in mm
 Pesì indicativi / Indicative weights

RETE BOCCA ASPIRANTE / INLET GUARD

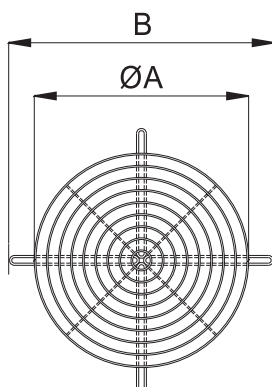

COD.	TIPO TYPE	A	B	kg
5RE9025	CCr25 x AL-ATX 200-225-250	200	245	0,4
5RE9031	CCr 31 x AL-ATX 280-315	320	384	0,6
5RE9035	CCr 35 x AL-ATX 355	360	434	0,8
5RE9040	CCr 40 x AL-ATX 400	400	479	0,9
5RE9045	CCr 45 x AL-ATX 450	460	529	1,1

Dimensioni in mm / Dimensions in mm
 Pesì indicativi / Indicative weights