

> FC HT

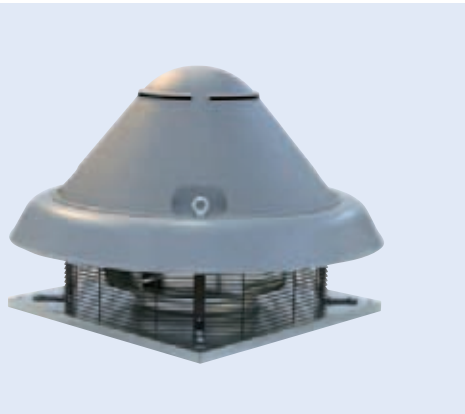

Torrini d'estrazione centrifughi F400 (Certificati secondo EN12101-3)

Centrifugal roof fan F400 (Certified according to EN12101-3)



Applus⁺

F400
Certificato / *Certificate*
nr 0370-CPD-1148

DESCRIZIONE GENERALE

Torrini di estrazione centrifughi per aspirazione diretta o canalizzata e adatti all'evacuazione di fumi ad alta temperatura.

La serie è idonea al funzionamento alla temperatura di +80°C ed è certificata CE in classe F400 dal laboratorio terzo indipendente APPLUS secondo la normativa EN12101-3.

CONSTRUZIONE

- Telaio di base in lamiera d'acciaio zincato.
- Rete di protezione in tondino d'acciaio trafilato e protetto contro gli agenti atmosferici.
- Girante a pale rovesce, ad alto rendimento aeraulico e bassa rumorosità, in lamiera zincata, bilanciata staticamente e dinamicamente secondo ISO 1940.
- Copertura in ABS, con idonee feritoie per il corretto raffreddamento del motore (struttura a cedimento controllato in caso di incendio).
- Motore asincrono trifase a norme internazionali IEC 60034, IEC 60072, EMC 2004/108/CE, LVD 2006/95/CE, marcato CE, IP55, classe F. Alimentazione: 400V, 50Hz trifase.

A RICHIESTA

- Versione 2 velocità con motore a doppia polarità (FC 2V).
- Interruttore di servizio.

ACCESSORI

- Controbases a murare (CB).
- Rete lato aspirazione (CCr).

DESCRIZIONE GENERALE

Centrifugal roof fans for direct or duct application and suitable for high temperature smoke extraction.

The series is suitable for running at the temperature of +80°C and is CE certified to F400 by the independent notified body APPLUS according to EN12101-3.

CONSTRUCTION

- Base frame in galvanized steel sheet.
- Protection guard in drawn steel rod protected against the atmospheric agents.
- Backward curved wheel in galvanized steel sheet, with high efficiency and low noise level, statically and dynamically balanced according ISO 1940.
- Upper cover in ABS, with appropriate slots for motor cooling (collapsing controlled cowl in case of fire)
- Double speed asynchronous three-phase motor manufactured according to international standards IEC 60034, IEC 60072, EMC 2004/108/CE, LVD 2006/95/CE, CE marked, IP 55, class F. Electric supply: 400V / 50 HZ three phase.

UPON REQUEST

- 2 speed version with double polarity motor (FC 2V)
- Service switch.

ACCESSORIES

- Counter-base to be walled-up (CB).
- Inlet side grid (CCr).

Le prestazioni aerauliche sono rilevate in conformità alla norma EN ISO 5801/AMCA 210 con densità dell'aria standard avente peso specifico 1.2 Kg/m³. Alimentazione 230V/1Ph/50Hz e 400V/3Ph/50Hz.

Air performances measured according to EN ISO 5801 / AMCA 210 standard with air density with 1.2 kg/m³ specific weight. Power supply 230V/1Ph/50Hz or 400V/3Ph/50Hz.

Lp: Livello di pressione sonora rilevato in condizioni di campo libero, propagazione semisferica, categoria di misura C a norma EN ISO 13349, nel punto di massimo rendimento, alla distanza di 6 metri e si presenta solo per fini comparativi.
Lw: Livello di potenza sonora ottenuto secondo norma ISO 3746. Tolleranza +/- 3 dB(A).

Lp: Sound pressure level measured in free field conditions, propagation hemispherical, measurement category C in accordance with EN ISO 13349, at the point of maximum efficiency, at a distance of 6 meters (for comparative purposes only).
Lw: Sound power level obtained in accordance with EN ISO 3746. Tolerance +/- 3 dB(A).

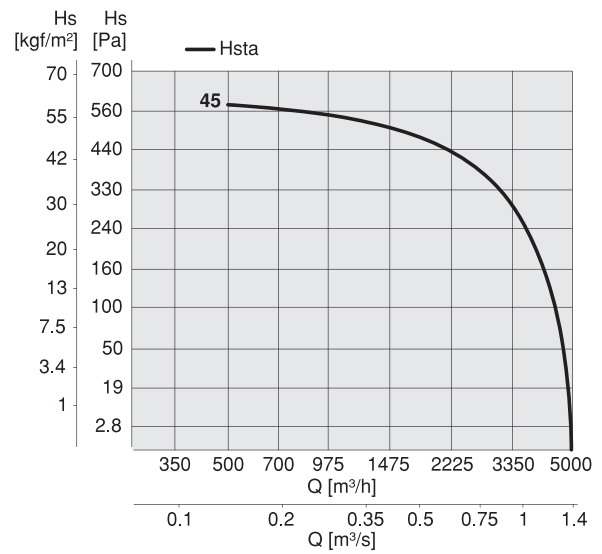
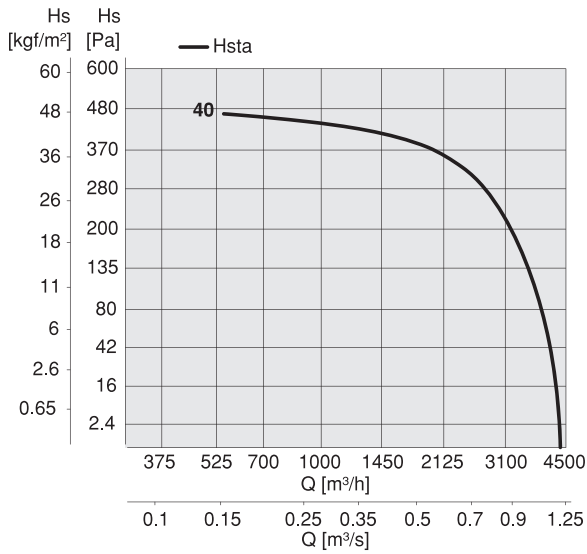

FC HT 404

Cod.	Modello Model	U	P	Pm (kW)	In (A)	IP/CL	Mot. (Gr)
1FC4203	FC HT 404	T	4	0,55	1,06	55/F	80

Livelli sonori - Sound levels / dB(A)

Size	db(A)	63	125	250	500	1000	2000	4000	8000	TOT
FC HT 404	Lw	50,8	64,5	71,5	74,1	74,9	72,0	68,5	57,1	79,9
FC HT 404	Lp	27,2	40,9	47,9	50,6	51,3	48,5	44,9	33,5	56,3

FC HT 454

Cod.	Modello Model	U	P	Pm (kW)	In (A)	IP/CL	Mot. (Gr)
1FC4503	FC HT 454	T	4	0,75	2,20	55/F	80

Livelli sonori - Sound levels / dB(A)

Size	db(A)	63	125	250	500	1000	2000	4000	8000	TOT
FC HT 454	Lw	52,0	65,5	73,4	76,3	76,2	73,2	68,8	58,4	81,4
FC HT 454	Lp	28,5	42,0	49,8	52,7	52,7	49,7	45,2	34,8	57,9

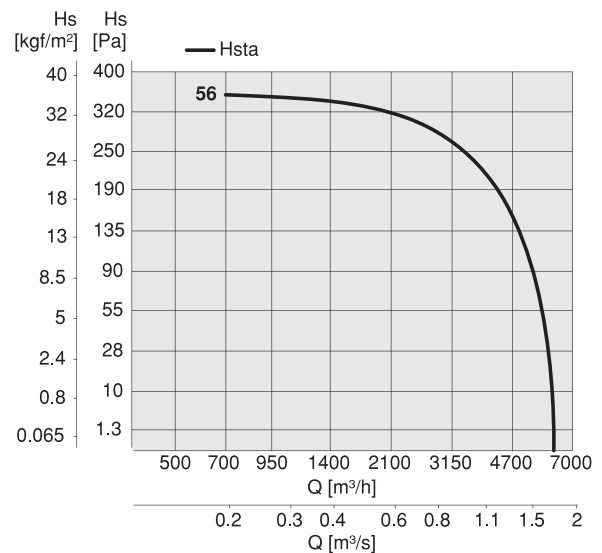
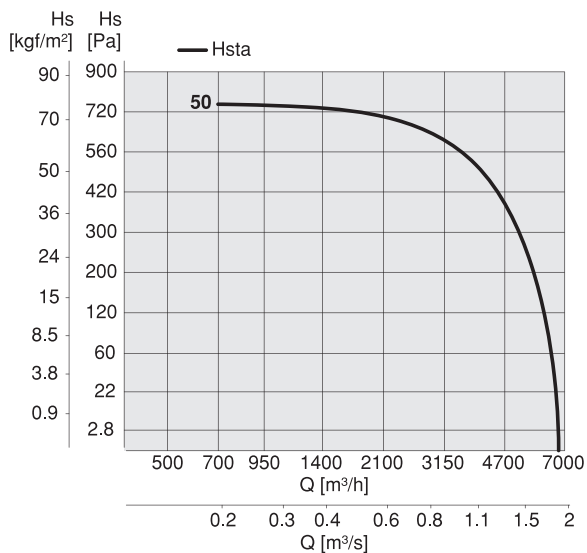

FC HT 504

Cod.	Modello Model	U	P	Pm (kW)	In (A)	IP/CL	Mot. (Gr)
1FC5105	FC HT 504	T	4	1,10	2,80	55/F	90S

Livelli sonori - Sound levels / dB(A)

Size	db(A)	63	125	250	500	1000	2000	4000	8000	TOT
FC HT 504	Lw	51,6	67,4	74,9	78,1	79,2	76,9	71,8	61,2	84,0
FC HT 504	Lp	28,0	43,9	51,3	54,5	55,6	53,3	48,2	37,7	60,4

FC HT 566

Cod.	Modello Model	U	P	Pm (kW)	In (A)	IP/CL	Mot. (Gr)
1FC5803	FC HT 566	T	6	0,55	2,00	55/F	80

Livelli sonori - Sound levels / dB(A)

Size	db(A)	63	125	250	500	1000	2000	4000	8000	TOT
FC HT 566	Lw	48,2	58,2	67,3	70,3	71,4	69,2	62,1	52,4	76,1
FC HT 566	Lp	24,6	34,7	43,7	46,7	47,8	45,6	38,5	28,8	52,5

Le prestazioni aerauliche sono rilevate in conformità alla norma EN ISO 5801/AMCA 210 con densità dell'aria standard avente peso specifico 1.2 kg/m³.
Alimentazione 230V/1Ph/50Hz o 400V/3Ph/50Hz.

Air performances measured according to EN ISO 5801 / AMCA 210 standard with air density with 1.2 kg/m³ specific weight.
Power supply 230V/1Ph/50Hz or 400V/3Ph/50Hz.

Lp: Livello di pressione sonora rilevato in condizioni di campo libero, propagazione semisferica, categoria di misura C a norma EN ISO 13349, nel punto di massimo rendimento, alla distanza di 6 metri e si presenta solo per fini comparativi.
Lw: Livello di potenza sonora ottenuto secondo norma ISO 3746. Tolleranza +/- 3 dB(A).

Lp: Sound pressure level measured in free field conditions, propagation hemispherical, measurement category C in accordance with EN ISO 13349, at the point of maximum efficiency, at a distance of 6 meters (for comparative purposes only).
Lw: Sound power level obtained in accordance with EN ISO 3746. Tolerance +/- 3 dB(A).

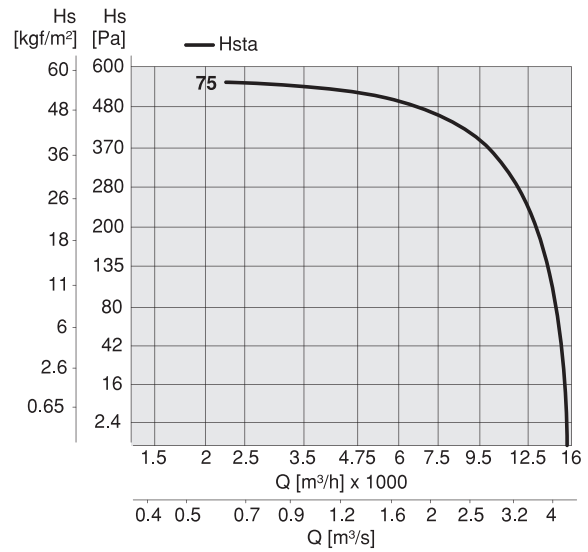
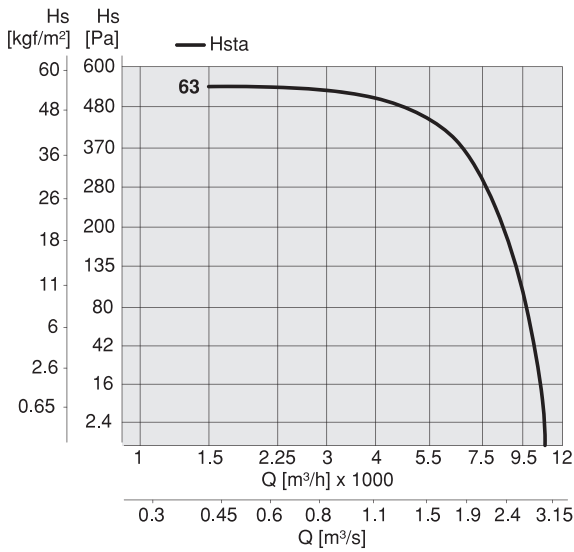

FC HT 636

Cod.	Modello Model	U	P	Pm (kW)	In (A)	IP/CL	Mot. (Gr)
1FC6503	FC HT 636	T	6	1,10	3,40	55/F	90L

Livelli sonori - Sound levels / dB(A)

Size	db(A)	63	125	250	500	1000	2000	4000	8000	TOT
FC HT 636	Lw	56,9	67,9	74,1	76,2	77,4	75,3	69,1	59,6	82,3
FC HT 636	Lp	33,3	44,3	50,5	52,6	53,8	51,8	45,6	36,0	58,8

FC HT 756

Cod.	Modello Model	U	P	Pm (kW)	In (A)	IP/CL	Mot. (Gr)
1FC7703	FC HT 756	T	6	1,80	5,00	55/F	100L

Livelli sonori - Sound levels / dB(A)

Size	db(A)	63	125	250	500	1000	2000	4000	8000	TOT
FC HT 756	Lw	58,2	70,5	77,2	80,4	81,3	79,3	74,4	66,1	86,3
FC HT 756	Lp	34,6	46,9	53,7	56,8	57,8	55,7	50,9	42,6	62,7

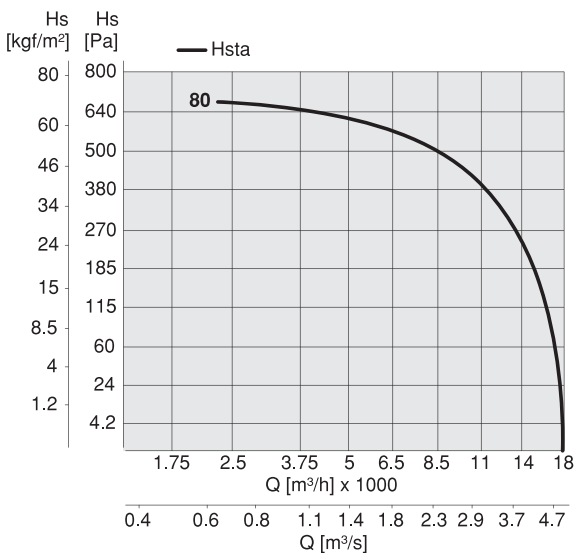

FC HT 806

Cod.	Modello Model	U	P	Pm (kW)	In (A)	IP/CL	Mot. (Gr)
1FC8104	FC HT 806	T	6	3,00	6,60	55/F	132S

Livelli sonori - Sound levels / dB(A)

Size	db(A)	63	125	250	500	1000	2000	4000	8000	TOT
FC HT 806	Lw	61,1	76,6	82,4	86,6	85,7	87,0	84,8	76,0	92,8
FC HT 806	Lp	37,5	53,1	58,9	63,0	62,2	63,4	61,3	52,4	69,2

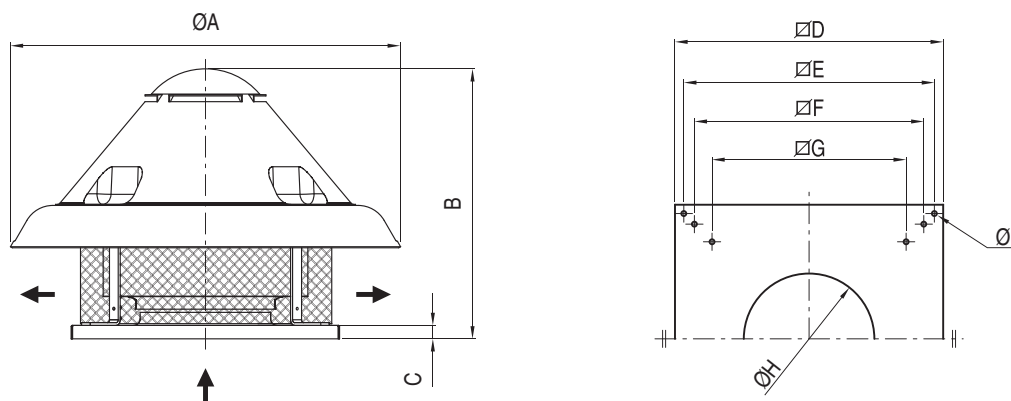

FC HT	ØA	B	C	D	E	F	G	ØH	ØI	PESO (kg)
40	900	640	38	650	600	530	471	296	12	30
45	900	650	38	650	600	530	471	296	12	38
50	1100	750	38	760	710	650	550	320	14	55
56	1100	750	38	760	710	650	550	370	14	57
63	1300	850	38	930	870	775	665	430	14	75
75	1300	880	38	930	870	775	665	480	14	108
80	1300	880	38	930	870	775	665	530	14	118

Dimensioni in mm / *Dimensions in mm*
 Pesì indicativi / *Indicative weights*